

Operations manual

Oliver™

Innovate. Build. Repeat.



Size Right

Sizer (2, 4, 6)

Version 1.0 | 1/3/23

Size Right® _____

The following instructions apply to the Oliver Size Right® models #2,4 & 6. These instructions contain information on installation and calibration. Please read and completely understand these instructions before proceeding to install the equipment.

Oliver Manufacturing Company Inc. reserves the right to change specifications, models, components, or materials at any time without notice. For further detailed information and any questions regarding the equipment, call the Oliver technical representative for your area. For parts or service call toll free 1 888 254-7813 or phone 719 254-7814, fax 719 254-6371, email contactus@olivermfgco.com.

Please have this operation manual available when contacting Oliver Manufacturing Company Inc.

MACHINE SERIAL NUMBER _____

USE CAUTION!

Always use caution and common sense when unboxing equipment.

Read operator's manual before using machine.

Always wear eye protection when inspecting or adjusting machine.

Always lock out power when performing maintenance or service.

Always insure machine and components are electrically grounded.

Make Safety First

Oliver Manufacturing Company Inc.

P.O. Box 512

Rocky Ford, CO 81067

www.olivermfgco.com

TABLE OF CONTENTS

Introduction.....	3.0
Installation	4.0
Operation	5.0
Seed-flow Diagram	6.0
Start-up.....	7.0
Adjustments.....	9.0
Changing Cylinders.....	10.0
Conveyor.....	11.0
Belts.....	13.0
Drive Shaft and Bearings.....	15.0
Wiper Blades.....	17.0
Trunion Bearings.....	18.0
Cleaning and Maintenance.....	19.0
Safety.....	20.0

INTRODUCTION

Oliver's Size Right® model # 2, 4 & 6 utilize a cogged timing belt, designed to accurately size seed by width (using round hole cylinders) or by thickness (using slotted hole cylinders).

The following instructions apply to Oliver's Size Right® No. 2,4 & 6. The drawings in this manual are representative of the Size Right® No. 2,4 & 6. Use them as a guide for proper installation and operational procedures.

Read these instructions completely before proceeding to assemble, install and operate this machine.

This machine should be installed, operated and serviced by qualified individuals. Follow local, state and federal regulations for proper installation and operational requirements. Follow proper OSHA regulations for lockout/tag-out procedures.

All materials should be cleaned prior to sizing.

Please have this manual accessible when contacting factory customer service personnel or the Oliver representative for the area.

**REPORT ANY SHIPPING DAMAGE
IMMEDIATELY!**

INSTALLATION

1. Remove the sizer unit and remaining contents from the shipping carton and check for lost or damaged parts.

Report any damage immediately!

2. Place the sizer in a desired location, making sure the unit is level or that the inlet is some what higher than the outlet. (Oliver builds a 1/2" increase in cylinder length from the seed inlet to the cylinder outlet. This aids in the seed clean-out). Allow a minimum of two feet on each side for the removal of cylinders. A work platform for changing upper cylinders on a #6 is recommended for operator safety.

3. Have a qualified electrician wire your motor, making sure to follow the National Electrical Codes for the area. Check for proper motor rotation. A label on the motor indicates which direction it should run.

Gearmotor with motor rotation sticker.



4. Air inlet/outlet openings on the machine help to reduce excess dust from within the machine. **Dust evacuation port.** A 400 CFM volume is recommended for normal operating conditions. An additional connection is required on the discharge of the vibrating conveyor for additional dust control.

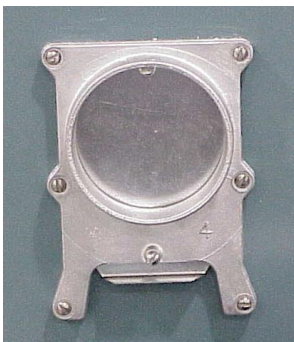

Air inlet assists in air flow

OPERATION

Dispense seed into the feed hopper on the top of the machine. The flow of seed passes through the weighted feed gate. The desired flow may be achieved by **adjusting the counterweights and/or set points mechanism.**



counterweight



set points

The seed flow is equally divided between the sizing cylinders by a gravity splitter. As the cylinder rotates, smaller seed “**thrus**” drop through the cylinder openings as the larger seed “**overs**” continue down the length of the cylinder, discharging over the end of the cylinder.

All of the seed that drops through the cylinder, discharges through a full length opening, called the “**thrus discharge spout**”, located at the bottom of the sizer. All of the seed that passes over the end of the cylinder combines and discharges from the “**overs discharge spout**” located at the bottom of the drive end (opposite the inlet end).

Refer to the illustration on the next page (6.0)

A rotating wiper blade assembly located above the cylinder, helps keep the cylinder openings clear.

Optional vibrating conveyors are available to move discharged seed from the sizer. A single vibrating conveyor carries discharged “thrus”. A double vibrating conveyor carries both “thrus” and “overs”.

Optional roller cleaning systems are available to clean lodged seed from the cylinders. Manual or pneumatic cleaning systems operated are available.

Seed flow

Size Right® Model #2

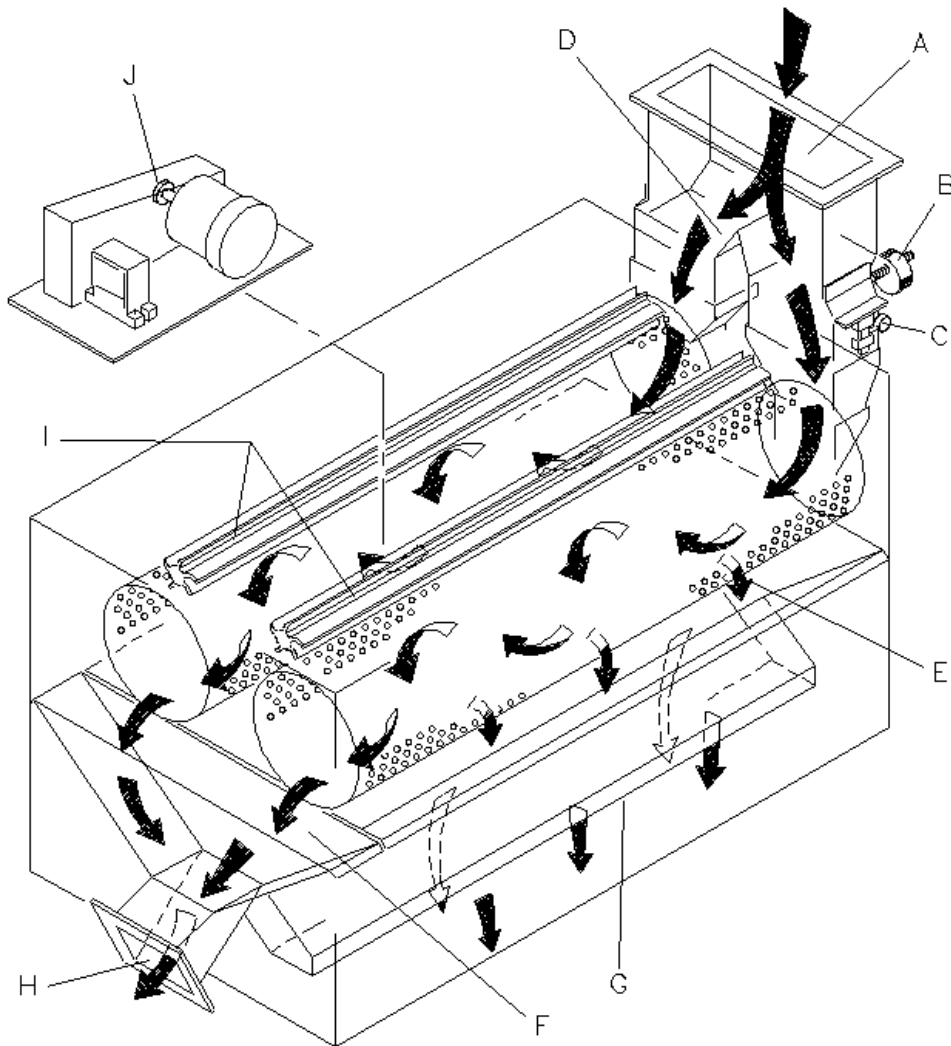

Start-up



Before turning the machine on, make sure the cylinder is locked into place and there is a tight fit between the intake hub and the **felt seal**.



Make sure all doors are in place and locked with the **special key**. This key prevents access to the cylinders while the machine is operating. **Keep this key in a secure location!**



Check the gearmotor for an adequate oil level, by removing the **oil level plug** located on the top side of the gearmotor. The oil should be filled to the bottom edge of the oil level plug.



The **belt take-up**, which is located on the lower part of each belt section, will take up extra length of belt and assist in the changing of timing belts.

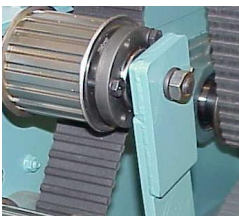

The belt tensioner located on the top part of each belt section, should be adjusted to the proper tension. **Caution! Do not overtighten!**



Check the **wiper blade** assemblies for any missing or loose bolts. **Recheck after 120 running hours and torqued to 200 inch pounds or 16 ft pounds.**



To equally disburse seed across the **feed hopper**, make sure the seed is being fed straight down and in the center of the hopper. An optional hopper box extension is available from the factory.

To ensure even seed flow to all cylinders, make sure all feed gate valves in the feed hopper are **open (#4 & 6)**.



Feed gate valves in open position

If individual cylinders are to be closed down, move the feed gate valve handle to **closed (#4 & 6)**.

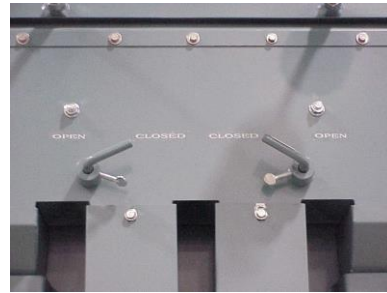

Feed gate valves in closed position

Make sure the rubber baffle in the overs discharge spout is hanging straight down and not creating a potential blockage for light seed **(#4 & 6)**.

To ensure the correct alignment of all moving parts, start the sizer and run for a short period of time.

Begin seed flow to the machine at a low capacity to get familiar with how the machine operates. Slowly increase the seed flow if a higher capacity is desired.

9.0

Adjustments



The counterweight, located on the inlet feed hopper, regulates the minimum to maximum flow of seed entering the hopper. The desired level of seed is obtained by monitoring a constant flow of seed through the front inspection window on the feed hopper and adjusting the counterweight accordingly.

To **increase** the volume of seed entering the hopper, turn the counterweight **clockwise**.

To **decrease** the volume of seed entering the hopper, turn the counterweight **counterclockwise**.



The **set points**, located on the side of the feed hopper, may be locked into position to assure a constant flow rate. The flow rate is fixed when one gate lever is held motionless by the upper and lower set points. Set points may also be set for a maximum and minimum flow rate, by locking the upper and lower wingnuts in the desired position and allowing one gate lever to float between the two.

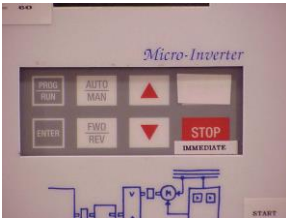

To adjust the cylinder speed, press the up or down arrow on the inverter control box. The recommended speed for a cylinder is 45 to 60 RPM.



Cylinder pin location versus cylinder speed has a direct relation. The cylinder pin adjustment location is located by the timing plate directly behind the sensor on the upper cylinder, left hand side, looking at the drive end. This timing plate may rotate left or right to reposition the cylinder pins. As the cylinder speed increases, the pins may advance farther down and make pin removal harder.

Follow lockout/tag-out procedures before making any adjustments! If this occurs, loosen three bolts on the timing plate and rotate the timing plate **clockwise** in 1/4" increments. Retighten bolts and run sizer. The cylinder pins will relocate at a more horizontal position. Cylinder pins may be moved within (+/-) 15 degrees of horizontal position. To verify the cylinder speed, an access hole for a



Cylinders

Changing Cylinders

**FOLLOW PROPER OSHA REGULATIONS
AND SAFETY PROCEDURES!**



Before changing the cylinders, follow proper OSHA regulations for lockout/ tag-out procedures.

To change a cylinder, turn the special fasteners on each end of the doors using the supplied key. Rotate the two grab-handles on the top of each door and lift off the door.

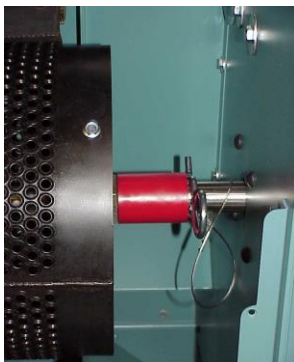

Remove the quick disconnect pin from the drive shaft, slide the coupling collar towards the drive end, and remove the cylinder from the sizer.

When installing a cylinder, make sure the intake hub fits over the intake spout and rests on the two trunion bearings.

Ensure the beveled end of the spider stub shaft matches the beveled end of the cylinder driveshaft. Slide the coupling collar over the mated ends of both shafts and insert the quick disconnect pin into the cylinder drive shaft. Reinstall the cylinder access door and lock the door with the special key.



When replacing a slotted or conical cylinder with a tri-bar cylinder; the wiper blades must be adjusted upward to allow for the larger diameter tri-bar cylinder.

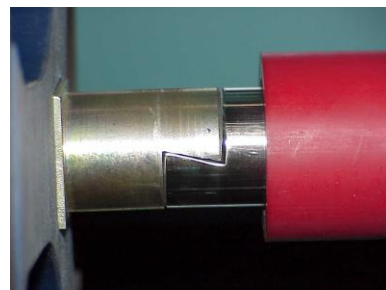

Conveyor

Reversing Discharge Flow On Vibrating Conveyors

**FOLLOW PROPER OSHA REGULATIONS
AND SAFETY PROCEDURES!**

To reverse the discharge flow on the vibrating conveyor toward the drive end, the conveyor must be removed from the bottom of the sizer and positioned so the deepest end of the trough is facing toward the drive end.

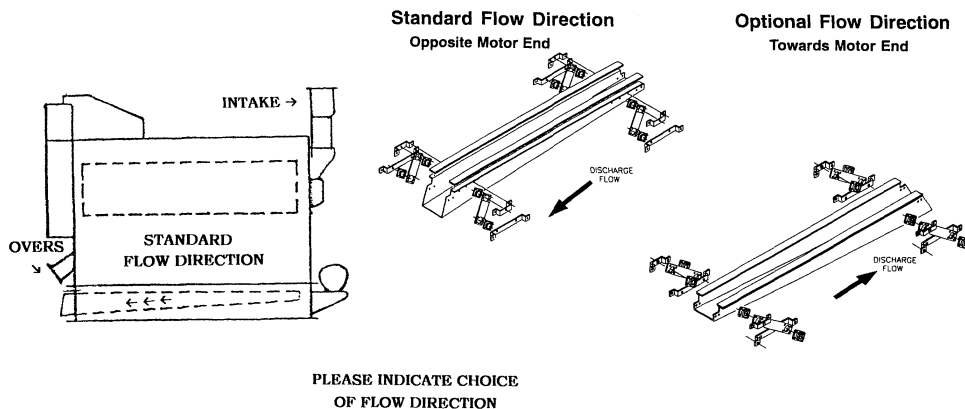

1. Remove all trough guards and detach the vibrating conveyor from the sizer.
2. Disconnect the conveyor trough arms from the trough.
3. Turn the deepest end of trough towards the drive end.
4. Reverse the position of the conveyor trough arms, making sure that the bottom of the arms are positioned in the same direction as the desired discharge flow.

Reverse the direction of the conveyor trough arms only!

5. Reconnect the trough arms and tighten all nuts and bolts.
6. Check all of the trough arms to see that they are installed in the same direction as the desired discharge flow.
7. Reinstall the conveyor under the sizer and secure it in place.
8. Replace all the trough guards.
9. Perform a trial run to test the seed flow direction. If installing a vibrating conveyor on a sizer that has never had one, check the edge of the thrus discharge for "bolted on" angle mounts used for anchoring the sizer to the floor. **These angle mounts must be removed before attaching the vibrating conveyor, or serious damage could occur.**

Standard Flow Direction Opposite Motor End

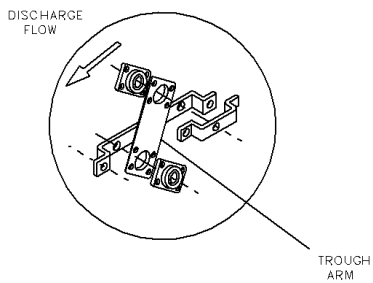

Optional Flow Direction Towards Motor End

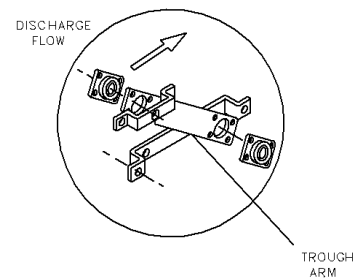

REMOVE



Belts

Changing Belts (removing)

**FOLLOW PROPER OSHA REGULATIONS
AND SAFETY PROCEDURES!**

1. Remove the drive guard door (use special key).



2. Loosen the upper belt tensioner.

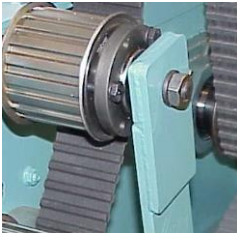

3. Lower the lower belt take-up pulley.



4. Loosen all bearing set collar locks on the bearing plate.



5. Remove two bolts on each end of the bearing plate.

6. Remove bearing plate with bearings from drive.



REMOVE



Do not remove bearings from the bearing plate, this may cause misalignment of the drive shaft when reinstalling!

Changing Belts (installing)



1. Position new belts on the drive pulley of the gearmotor and cylinder pulley.

2. Reinstall the bearing plate and check drive shafts for proper alignment. Tighten all bolts on each end of the bearing plate assembly.



3. Replace collar locks per manufacturer's specifications. Make sure all of the drive shaft key ways are in the "up" position.



4. Hand lift the lower belt take-up pulley to the belt and tighten fastening bolt.

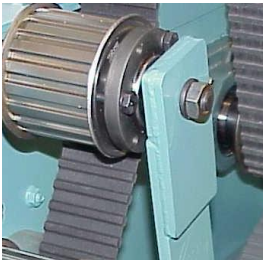

5. Adjust the upper belt tensioner to the 15 degree mark on the indicator. Make sure the belt tensioner is on the proper side of the belt.

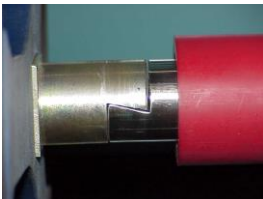

6. After installing the new belt, make sure all quick disconnect pins are facing outward.

For proper belt tension, readjust the upper belt tensioner after running the sizer for a short period of time.

Drive Shaft and Bearings

Changing Cylinder Drive Shafts and Bearings

Always follow proper OSHA regulations for lock-out/Tag-out procedures.



1. Remove the drive guard door. **(Use special key).**
2. Loosen belts. **(Refer to page 13, BELTS).**
3. Remove cylinder access door. **(Use special key).**



4. Remove all cylinders from machine. **(Refer to page 10, CYLINDERS).**

5. Remove bearing plate assembly. **(Refer to page 13, BELTS).**

6. Loosen all of the cylinder drive shaft bearing set screws and collar locks. Remove the cylinder drive shaft and the remaining cylinder drive shaft bearing on the drive end bearing plate.

7. To install the new cylinder drive shaft bearings, reverse the procedure to the point of setting the set screws and collar locks on all bearings.

When installing a cylinder drive shaft, it must pass freely from one bearing to the other and be centered as close as possible on the hole.

8. Maintain a distance of 3-1/16" from the inside of the end plate to the first machined edge of the cylinder drive shaft and tighten all set screws on the collars of the drive bearings.



11. When installing a cylinder, make sure the intake hub fits over the intake spout and rests on the two trunion bearings.

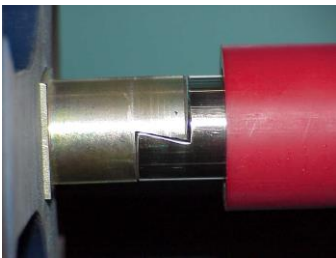

12. Make sure the beveled end of the spider stub shaft matches the beveled end of the cylinder drive shaft. The position of the driveshaft supports the cylinder spider stub shaft. This position will occur when the key ways are in the “up” position (**refer to page 14 - Belts**).

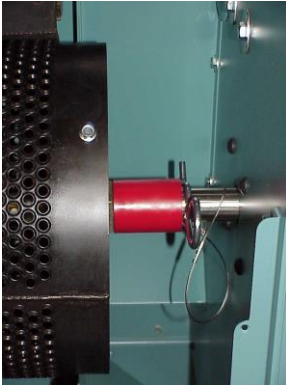

13. Slide the coupler collar over the mated ends of both shafts and insert the quick disconnect pin into the cylinder drive shaft.

Recheck the cylinder intake end to be sure that it is tight against the felt intake seal. The cylinder should be resting on the trunion bearings; this will assure proper alignment and rotation of the cylinder.

Wiper Blades

Replacing Wiper Blade Hubs

1. Remove drive belts.
2. Remove wiper blade pulleys.
3. Remove wiper blades.
4. Loosen collar locks on 4-hole flange bearings.
5. Loosen collar locks on 2-hole flange bearings.
6. Slide wiper blade shaft out of 2-hole flange bearing.
7. Loosen set screws on wiper blade hub and slide off of wiper blade shaft.
8. Slide on new hubs.
9. Replace shaft into 2-hole flange bearing & tighten collar locks on 2 & 4-hole bearings.
10. Replace wiper blades.
11. Replace wiper blade pulleys.
12. Replace belts.

Trunion Bearings

Replacing Trunion Bearings

1. Remove Cylinder.
2. Remove old trunion bearings.
3. Place bolt through new bearing. Tighten set screw.

Cleaning & Maintenance

The sizer is designed to be self-cleaning. The cylinder should empty itself continuously during operation. At the end of a sizing run, you may need to manually clean a few cylinder openings.

All bearings are greased at the factory during installation. It is recommended that each bearing be greased at the manufacturers' specified intervals.

After 100 hours of initial operation of the gearmotor, the housing should be thoroughly drained. While the oil is warm, add new oil to fill the housing to the proper oil level. Replace the oil plug.

After initial break-in of the sizer, the oil should be changed every six months or 2,500 operating hours (whichever comes first).

The following is a manufacturer's recommended lubricant chart:

	Ambient Temp.			
<u>AGMA</u>	<u>Range</u>	<u>Gulf</u>	<u>MOBIL</u>	<u>SHELL</u>
7 Comp	5 to 60 F	Senate 460	600W Super	Valvata J-460
Comp	50 to 140 F	Senate 680D	Ex, Heela Super	Valvata J-680

The gearmotor has been tested and adjusted at the factory. Dismantling or replacement of components must be done by the manufacturer to maintain the warranty.

Frequently check the oil level of the gearmotor. If the oil level is low, add lubrication through the filler plug until it comes out of the oil level plug on top of the gearmotor.

Inspect the vent plug often to ensure it is clean and operating.

Do not mix compounded oil and synthetic oil in the gearmotor!

Safety

Before attempting to service or engage in any internal inspection of the sizer, follow proper OSHA regulations for lockout/tag-out procedures.

Guards are provided with the machine to protect operators from injury. Doors should not be removed while the machine is operating. Guards and covers must always be secured in position before the operation of the machine.

OliverTM

Innovate. Build. Repeat.

Oliver Manufacturing Company • 27151 Harris Road • La Junta, CO 81050 • (888) 254-7814

olivermanufacturing.com