

# Operations manual

# **Oliver**<sup>™</sup>

Innovate. Build. Repeat.



## **Fluidized Bed Dryer**

Automated (DVB)

Version 1.0 | 1/18/23

<b>DVX Fluidized Bed Dryers - Reference Manual Version V</b>		
<b>Revision Table</b>		
<b>Section</b>	<b>Revision</b>	<b>Date</b>
Main Section: Introduction to Installation and Functional Operation Setting Up Machine from HMI Modes of Operation	V	3/6/2020
Appendix A: The PanelView Plus		
Appendix B: CompactLogix 5370 L2 PLC		
Appendix C: Power flex 525 Variable Frequency Drive		

# Contents

- I Installation and Functional Operation 1**
  - 1 Installation 3**
    - 1.1 Foundation Requirements .....3
    - 1.2 Handling .....3
    - 1.3 Protecting the Deck .....3
    - 1.4 Electrical Requirements.....4
    - 1.5 Clean Air Source.....4
  - 2 Functional Operation of the Fluidized Bed Dryer 5**
  - 3 Control Components of the FBD 9**
  - 4 Safety Considerations 11**
  
- II Setting Up the Machine from the HMI 12**
  - 5 Choosing the Machine Options 13**
    - 5.1 Fan VFDs ..... 15
      - 5.1.1 Fan Speed Scaling..... 16
      - 5.1.2 Fan Current, DC Bus Voltage, and Temperature alarm limits ..... 18
    - 5.2 Deck Eccentric VFD ..... 19
      - 5.2.1 Deck Eccentric Speed Scaling ..... 19
      - 5.2.2 Deck Eccentric Current, DC Bus Voltage, and Temperature alarm limits ..... 20
    - 5.3 Deck End Raise ..... 21
    - 5.4 Temperature Range ..... 22
    - 5.5 Blend Door ..... 23
    - 5.6 Machine Hand ..... 24
    - 5.7 Machine IP Addresses..... 25
  
- III Modes of the Machine 26**
  - 6 Auto Mode 28**
    - 6.1 Continous Mode ..... 28
      - 6.1.1 Fan Controls ..... 29
      - 6.1.2 Deck Eccentric Controls ..... 30
      - 6.1.3 Deck End Raise Controls ..... 31
      - 6.1.4 Sensor Readouts..... 31

6.1.5	Heater Controls .....	31
6.1.6	Start Button .....	32
6.1.7	Dust Hood Light .....	32
6.2	Batch Mode .....	33
6.2.1	Batch Timer .....	34
6.2.2	End Raise Cycle Timer .....	34
6.2.3	Deck Shake Timer .....	35
6.2.4	Current Timer Readouts .....	36
6.2.5	Differential Temp Alarm .....	37
6.3	Local and Remote Mode .....	38
6.4	Clean Out .....	38
6.5	Trim .....	39
6.6	Changing Recipes .....	40
<b>7</b>	<b>Diagnostic Mode</b> .....	<b>44</b>
7.1	Start Buttons for the Fans and Deck Eccentric .....	45
7.2	Deck End Raise Feedback .....	45
7.3	VFD Graphs and Readout .....	46

# List of Tables

1.1 Model Voltages and Total Amp Draws.....4

# List of Figures

- 2.1 Putting particles on the deck and adjusting (a) Particles drying early (b) and drying at the end of the deck (c) ..... 7
- 2.2 Putting particles on the deck and adjusting (a) Particles drying early (b) and drying at the end of the deck (c) ..... 8
  
- 3.1 The Programmable Logic Controller (PLC) CompactLogix L2..... 9
- 3.2 The Human Machine Interface PanelView Plus HMI ..... 10
- 3.3 The Variable Frequency Drive (VFD) – PowerFlex 525 ..... 10
  
- 5.1 Menu Bar ..... 13
- 5.2 Logging in as theengineer user ..... 14
- 5.3 Navigating to the Dryer Options Screen from the Control Panel ..... 14
- 5.4 Dryer’s installed options screen..... 15
- 5.5 Dryer’s installed options screen top menu buttons ..... 15
- 5.6 Selecting the Fan VFD Options..... 16
- 5.7 Fan options pop up window ..... 16
- 5.8 Fan scaling options ..... 16
- 5.9 Fan scaling Example for Dryer with no heat ..... 17
- 5.10 Fan scaling Example for Dryer with heat ..... 17
- 5.11 Changing Fan 1 speed command for Example 2 ..... 18
- 5.12 Setting output current (A) limits for Fan 1 ..... 18
- 5.13 Setting output current (A) limits for Fan 1 Example ..... 19
- 5.14 Selecting the Deck VFD Options..... 19
- 5.15 Deck options pop up window ..... 19
- 5.16 Deck scaling options ..... 19
- 5.17 Deck scaling options Example..... 20
- 5.18 Changing Deck speed command for typical setup..... 20
- 5.19 Setting output current (A) limits for Deck Eccentric..... 21
- 5.20 Setting output current (A) limits for Deck Eccentric Example ..... 21
- 5.21 Selecting the Deck End Raise Options ..... 21
- 5.22 Deck End Raise Options Screen ..... 21
- 5.23 Inputing Voltage Limits for Deck End Raise ..... 22
- 5.24 Forcing the Deck up and Down ..... 22
- 5.25 Voltage Feedback ..... 22
- 5.26 Selecting the Temperature Range settings and alarms..... 23
- 5.27 Temperature Range popup ..... 23
- 5.28 Temperature Range Settings..... 23
- 5.29 Navigating to the Blend Door calibration..... 23
- 5.30 Blend Door popup screen..... 23
- 5.31 Blend Door pulses input boxes..... 24

5.32	Blend Door Calibration.....	24
5.33	Machine Hand .....	24
5.34	Mode Selection .....	27
6.1	Control Panel.....	29
6.2	Airchest Controls Area.....	29
6.3	Fan Controls Area.....	30
6.4	Deck Controls Area.....	30
6.5	Deck Eccentric Pause Button .....	30
6.6	Deck End Raise Controls .....	31
6.7	Airchest Sensors .....	31
6.8	Dusthood Sensors.....	31
6.9	Heater Controls .....	32
6.10	Start Button - Machine Off.....	32
6.11	Start Button - Machine On and recipe running .....	32
6.12	Dust Hood Light Button - Light Off .....	32
6.13	Dust Hood Light Button - Light On.....	33
6.14	Control Panel in Batch Mode.....	33
6.15	Inputing Batch Timer settings for Batch Time length .....	34
6.16	Inputing Batch Timer settings for End Raise Cycle.....	34
6.17	End Raise Cycle Limts Example .....	35
6.18	End Raise Timer 5 Seconds Example.....	35
6.19	Deck Shake Timer.....	36
6.20	Deck Shake Timer Example for 2 seconds on, 10 seconds off, repeated through a 30 second batch cycle.....	36
6.21	Time Remaining .....	37
6.22	Time Remaining Deck Off.....	37
6.23	Navigating to the differential temp alarm settings.....	37
6.24	Differential Temp Alarm Popup Screen.....	38
6.25	Clean Out Screen.....	38
6.26	Loaded Values Clean Out Screen .....	39
6.27	Time Elapsed for each stage.....	39
6.28	Trim Settings.....	40
6.29	Trim Settings Fan1 Example at 40% to 55% trim settings.....	40
6.30	Navigating to the Recipe screen from the Control Panel .....	41
6.31	Recipe Setup Screen as an Operator user .....	41
6.32	Recipe Setup Screen as a Supervisor user.....	42
6.33	Recipe List with a new Recipe .....	43
6.34	Recipe Setup Screen with Update Recipe and Cancel buttons.....	43
7.1	Control Panel in Diagnostic Mode .....	44
7.2	Control Panel in Diagnostic Mode with Start Buttons Highlighted.....	45
7.3	Control Panel in Diagnostic Mode with Deck End Raise Feedback Highlighted	46
7.4	Graphs for Amperage (A), Voltage (V), and Temperature and the readout for the VFD frequency in diagnostic mode .....	46

**Part I**

**Installation and Functional  
Operation**



This manual contains several different sections. The first section will describe the installation procedure for the machine. Next, the functional operation and initial setup of the machine will be described. Then the operation of the machine in its various modes will be discussed. Finally, several attached appendices will be provided for description of related functions such as programming the PLC and HMI.

# Chapter 1

## Installation

This section explains the installation requirements for the Dryer. Your Dryer will have been tested many hours of operation at our facility to ensure the quality of the machine. Take care not to do anything that would damage it or compromise it.

### 1.1 Foundation Requirements

A solid, level foundation is required for safe and proper operation of the FBD. Vibrations from flooring can cause damage to the machine. A six-inch concrete slab is ideal but not essential. The FBD is fully counterbalanced to keep external vibrations to a minimum. However, the accuracy of the counterbalancing system is affected by the weight of the product on the deck and thus is dependent on the capacity and type of product being dried. Therefore we recommend that the Dryer be firmly attached to the floor. Please contact the factory or your Oliver representative for recommendations. When positioning the Dryer, be sure that you leave adequate clearance to operate the controls, open the electrical cabinet and remove the deck for changing or cleaning.

### 1.2 Handling

The DVX Fluidized Bed Dryer weighs several thousand pounds depending on the model and accessories ordered with it. Be sure that the handling equipment is adequate for the load. While handling the machine take extra care not to damage the deck, the air filters or any other parts of the machine. The fork tubes are designed to be used with 8-foot long forks (or fork extensions). Picking up the machine with shorter forks may damage the tubes. The fan motors are mounted on the tubes so any damage can have serious consequences for machine functionality. The machine is also equipped with lifting lugs at the corners of the mainframe which may be used to hoist the machine into place.

### 1.3 Protecting the Deck

The deck is the portion of the machine that actually contacts the product during the drying process. Take extra care not to damage it. During construction and installation, it is very common for contractors to use the surface of the deck as a work space or storage space for items they do not need. Please discourage this practice! The deck is designed to support a relatively uniform load of product over its entire surface. Storage of concentrated loads on the deck has resulted in bent or broken deck frames and in damage

to the wire overcovers. We recommend that a non-combustible surface such as a sheet of 16-gauge steel be placed over the deck to protect it until the Dryer is ready for to be used. Do not weld anything to the machine as the sensitive control electronics could be seriously damaged. If it is necessary to weld or cut above the machine during installation take extra care to prevent damage from falling debris or sparks.

### 1.4 Electrical Requirements

The DVX Fluidized Bed Dryer comes with a complete electrical cabinet that is wired to all of the electrical components such as the motors, hydraulic cylinders sensors, and dust hood light. Typically the only wiring the electrician installing the machine needs to worry about is the running of the power source to the electrical cabinet. Typical voltages would be 230V and 460V, three phase, at 60Hz. Other voltages are possible, but need to be addressed when the order is placed.

Machine	DVX304	DVX307	DVX410	DVX512	DVX616
208/230V	30 Amps	50 Amps	70 Amps	115 Amps	150 Amps
480V	20 Amps	30 Amps	50 Amps	70 Amps	80 Amps

**Table 1.1:** Model Voltages and Total Amp Draws

**NOTE: As of November 1st 2012, the warranty covering the PLC and VFDs will become void if the electrician enters the cabinet from the top. The PLC and VFDs will suffer damage if dust or debris from drilling into the cabinet enters the air vents on the units. The electrician must enter the cabinet either from the bottom, or from the bottom of either side panel, below the vents on the VFD. Failure to do this will result in voiding the warranty on the PLC and the VFDs.**

### 1.5 Clean Air Source

The FBD requires a clean air source in order to keep the deck from being contaminated by dust blown in through the fans. The air chest comes supplied with air filters for a machine is that is going to be bolted down to a solid slab foundation. For those who want to use an external air filtration source, it is also possible to either raise the machine, or to suspend it over a space where the air is being pumped in. If you need consultation on how to get clean air to your machine, please call the Oliver team.

## Chapter 2

# Functional Operation of the Fluidized Bed Dryer

The DVX family of Fluidized Bed Dryers (FBD) is based on Oliver's legendary Voyager and Maxi-Cap Gravity Separators. Unlike the gravity separator, which is designed to separate like particles of different specific gravities, the FBD is designed to remove moisture, and possibly heat, from the particles on the deck. Though the function is slightly different, it works on a very similar concept as the gravity separator.

The FBD operates on a concept discovered by Archimedes, a Greek philosopher and mathematician, who discovered that all bodies, floating in or submerged in a liquid, are buoyed up by a force exactly equal to the weight of the liquid they displace. In the case of the FBD, the liquid is the air blown by the fans, and the bodies are the particles being dried. What Archimedes was getting at is that we can use air to lift the particles on the deck, and that the amount of air needed is related to the weight of the particles that need to be lifted.

As the air moves past the particles it acts in the same way a swamp cooler does by evaporating the water around the particles. Because it takes a large amount of energy to change the state of the water from a liquid to a vapor, the surrounding air becomes cooler as it passes the particles on the deck, as the energy needed to switch the state of the water comes from the air, and from the particles themselves. Hotter air from the fans will speed up the drying process because it has more heat that can be dissipated to the water, increasing the rate at which the water changes state. This process of the water being evaporated and the air being cooled as it passes through the seeds allows us to monitor how dry the seed is as it passes over the deck. If the air is at the same temperature above and below the particles, then there must not be any evaporation, and the seed is dry.

In order to move the seed along the deck, there must be a process that allows the seed to propagate. This is done via the Deck Shake and the Deck End Raise. The Deck Shake also helps with the lifting of the seed as it gives momentum to the particles, as well as providing a mechanism for separating out the particles that are clumped together from being wet. The Deck End Raise allows gravity to assist or resist the movement of the particles on the deck.

With the combination of the air, the Deck Speed, and the Deck End Raise, the particles will enter a quasi-fluidic state, meaning that the particles will almost act like a liquid, moving along the deck. As the air is increased, the particles will start to move more vertically in a layer, and the deck speed and end raise will drive the product down the deck like a liquid. The faster the deck speed and the steeper the end raise from feeder to discharge, the faster the particles will move. The higher the air speed the faster the

product will dry.

For normal use with ambient air, the typical operation of the machine is to set the fans at 100% and then to adjust the deck speed until all of the heavier particles are able to enter into the quasi-fluidic state, and then to adjust the End Raise until the product is just dry at the end of the deck. For example, consider Figure 2.1. Here particles, represented by red dots, have been put onto the deck (a), and the FBD has been set to have 100% Fan Speed, and perhaps the deck has been set at 500 RPMs, and the particles have been put into a quasi-fluidic state and are moving up the deck (b). When the particles are tested at the end of the deck, they are dry, but they are also dry at the center part of the deck. This means that the deck end raise can be increased, moving the deck towards a flat position and a slope from the Feeder to the Discharge End (c). This will increase the speed of the particles across the deck, decreasing the drying and process time. The Deck Speed can also be increased instead of the Deck Angle.

On the other hand, the particles might be introduced to the deck and the fans turned up to 100% and the Deck Speed set at 500 RPMs, and the deck angle could be too steep from the Feed End to the Discharge, keeping the particles from drying. See Figure 2.2. The particles are put on the deck (a) and the deck is adjusted but the particles are not drying at the end of the deck. The Deck End Raise should be decreased to hold the particles on longer so that the particles will dry.

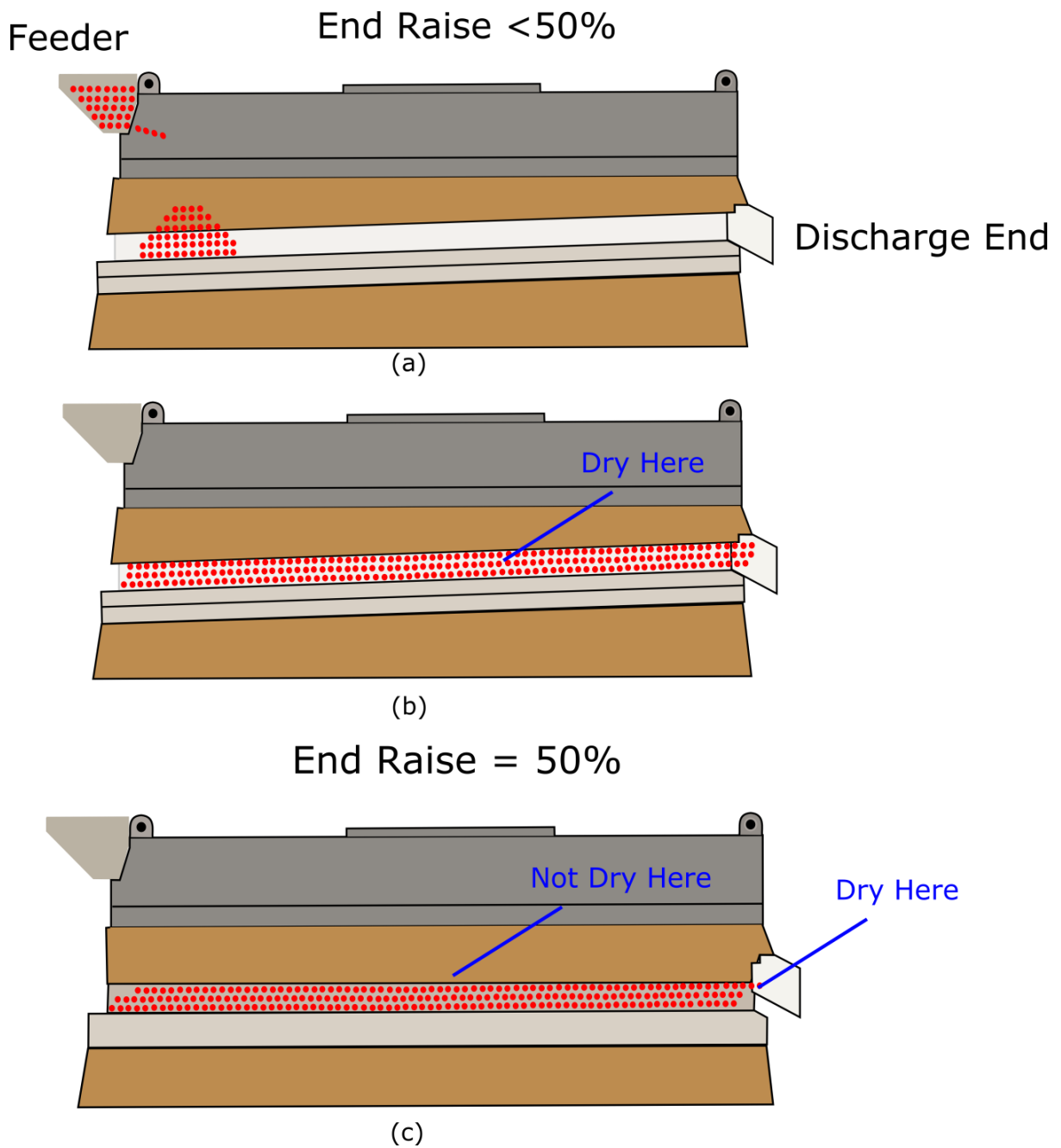

**Figure 2.1:** Putting particles on the deck and adjusting (a) Particles drying early (b) and drying at the end of the deck (c)

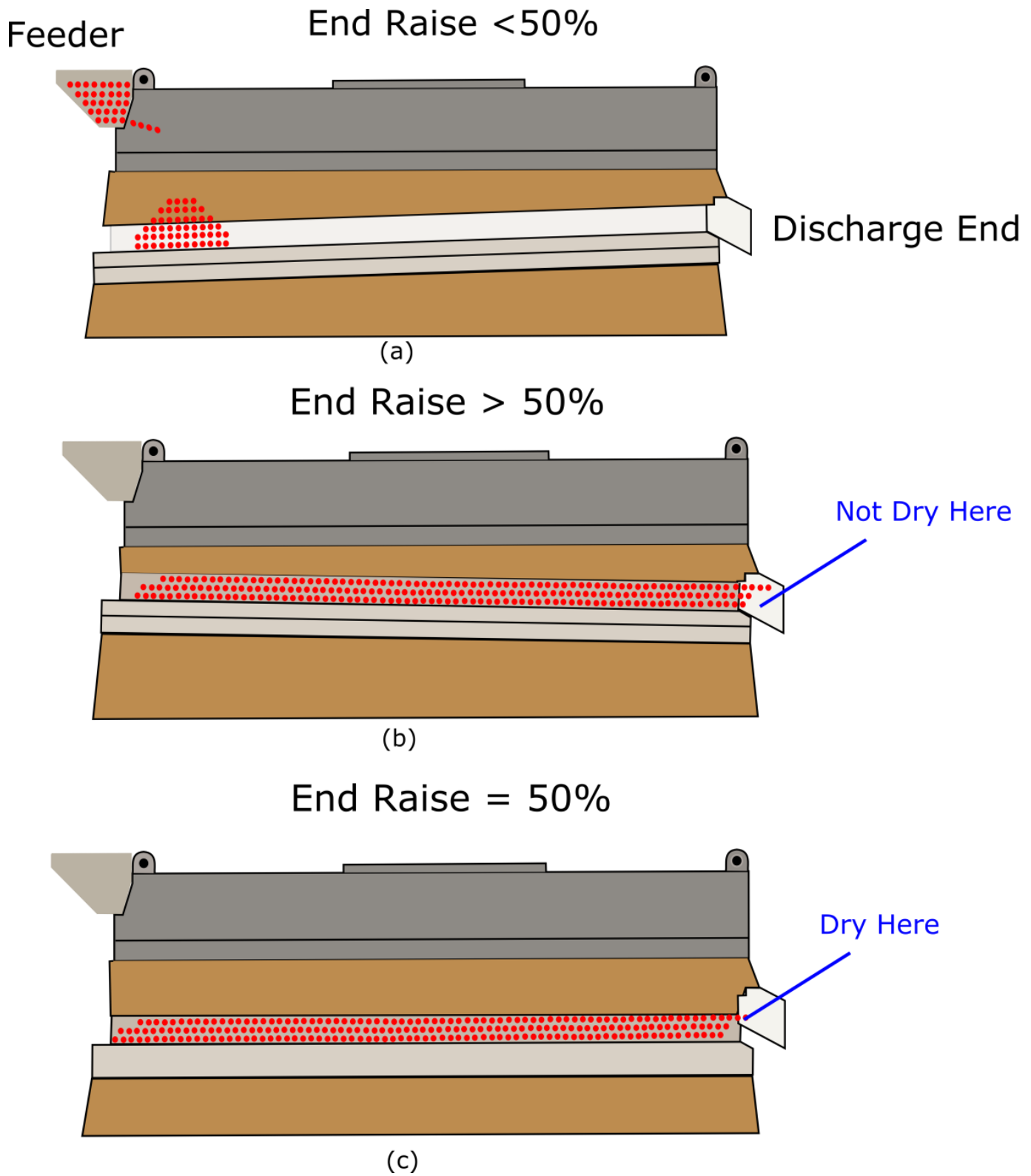
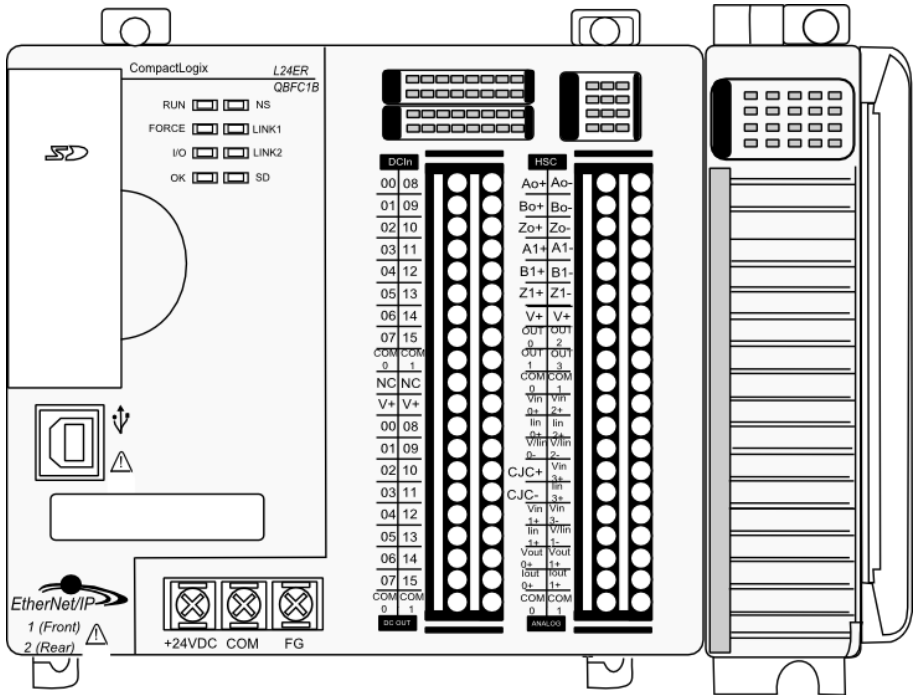

**Figure 2.2:** Putting particles on the deck and adjusting (a) Particles drying early (b) and drying at the end of the deck (c)

# Chapter 3

## Control Components of the FBD

The DVX Fluidized Bed Dryer is an automated machine, which means that instead of having dials or mechanical devices to control the air flow, deck speed, and other components that have to be individually controlled in a mechanical way the entire process is done via a Human Machine Interface (HMI) and a Programmable Logic Controller (PLC). The HMI is a touchscreen that allows the user to input desired settings, which are then transferred to the PLC, which then uses its internal programming to run the machine. The PLC is like a small computer. It has a processor, memory, inputs, outputs, and a small display for additional controls. It is the brains of the automated machine. One additional component to the automated process is the Powerflex 40 Variable Frequency Drive (VFD). It is what the PLC uses to give exact control over all of the fans and the eccentric motor. It is critical to know and understand the difference between the three when going through the guide.



**Figure 3.1:** The Programmable Logic Controller (PLC) CompactLogix L2





Featuring

**Rockwell  
Automation**

CompactLogix PLCs | Powerflex 40 Drives

**HMI Version:** [Dryer\\_410\\_PV\\_R10](#)

**PLC Version:** [DVX410\\_PF\\_R1D](#)

**Figure 3.2:** The Human Machine Interface (HMI) – PanelView Plus HMI



**Figure 3.3:** The Variable Frequency Drive (VFD) – PowerFlex 525

# Chapter 4

## Safety Considerations

### **Important Safety Precautions for Using the DVX Fluidized Bed Dryer**

- Always shut off the lock-out power when performing maintenance or service.
- Always insure that the dryer and components are electrically grounded.
- Always wear face and eye protection when inspecting or adjusting the dryer.
- Never operate the dryer with the air filters removed.
- Never operate the dryer with the deck removed.
- Never operate the dryer with missing or worn parts.
- Never operate the dryer with the air chest boot removed.
- Never operate the dryer with worn or damaged decks.
- Never use the dryer as a table or work station.
- Never stand on the dryer.
- Always wear ear protection when operating the dryer.
- Always keep dryer clean and properly adjusted.
- Periodically inspect the dryer for wear and correct operation.

## **Part II**

# **Setting Up the Machine from the HMI**

# Chapter 5

## Choosing the Machine Options

The main menu bar is the navigational tool for moving between the screens of the HMI, and is located on the right side of the HMI screen(s). See Figure 5.1. The number of buttons in the menu is based on which user is logged in i.e. operator, supervisor, or engineer. The operator will only have access to the control panel and clean out menu buttons. The supervisor will additionally have access to the trim button. And the engineer will have all of the supervisor options as well as the dryer options menu button used to set up the available options for the dryer. <sup>1</sup>

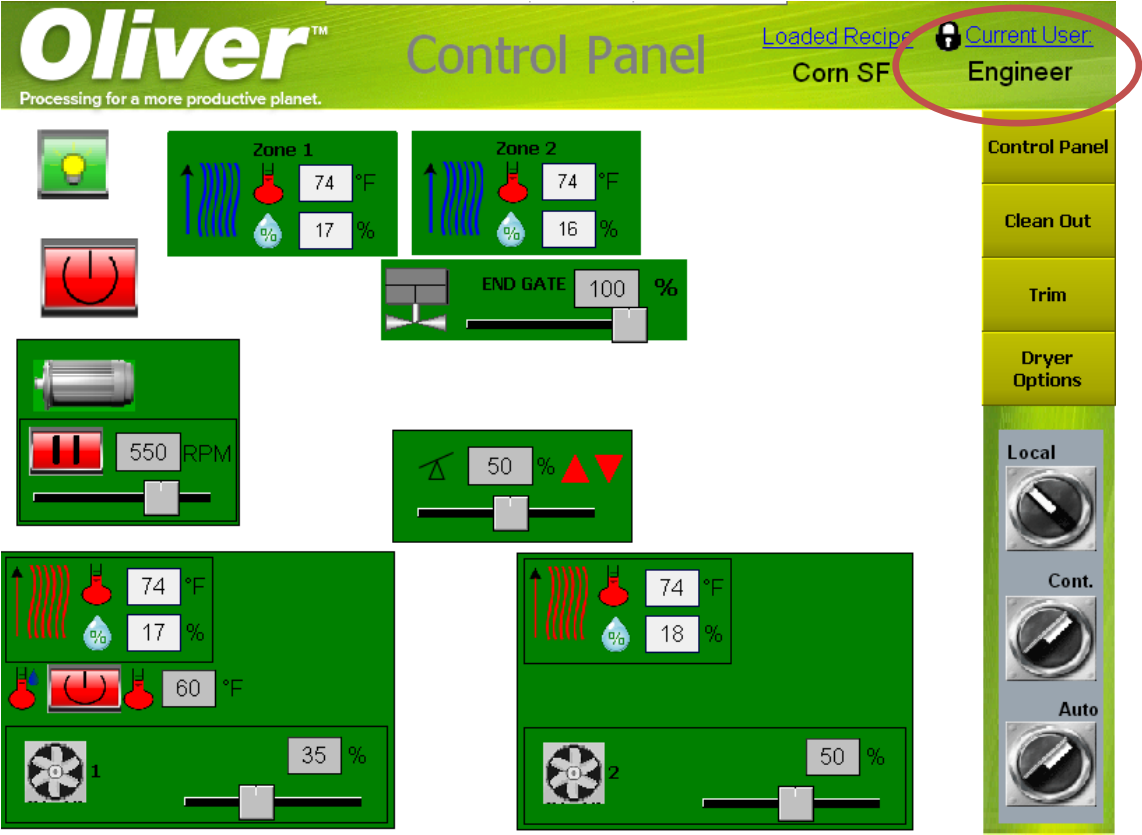
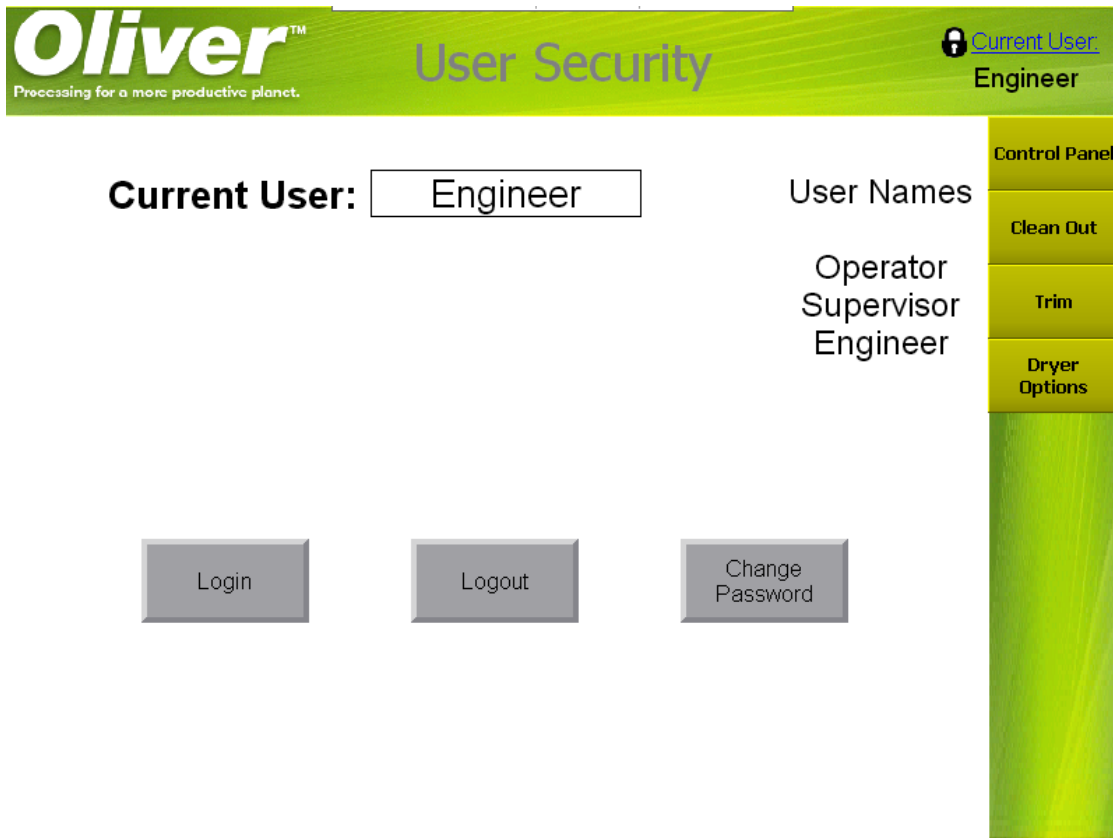

**Figure 5.1:** Menu Bar

In order to arrive at the options for the dryer, the user must be logged in as the engineer user. To do this, click on the current user hyperlink at the top right of the control panel screen. This will take the user to the user security screen. From there, click Login button and enter engineer as the logged in user, and the password for the engineer user in the password box and using the pop up keyboard to enter the password. See Figure 5.2. <sup>2</sup>

<sup>1</sup>see Oliver’s training video entitled “Menu Navigation”

<sup>2</sup>see Oliver’s training video entitled “Logging in a User and Changing User Password”



**Figure 5.2:** Logging in as the engineer user

Once the user is logged in as the engineer user, press the menu button marked Dryer Options on the right hand side to go to the installed options screen. See Figure 5.3

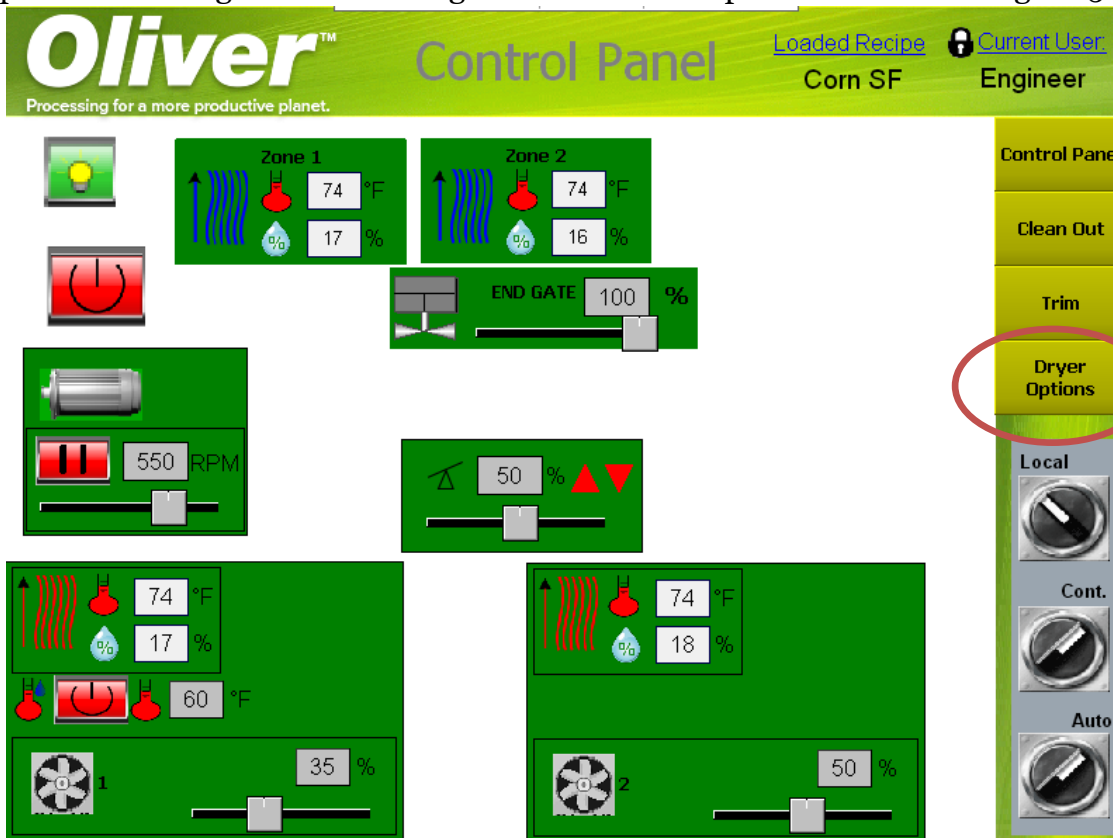

**Figure 5.3:** Navigating to the Dryer Options Screen from the Control Panel

The installed options screen is shown in Figure 5.4.

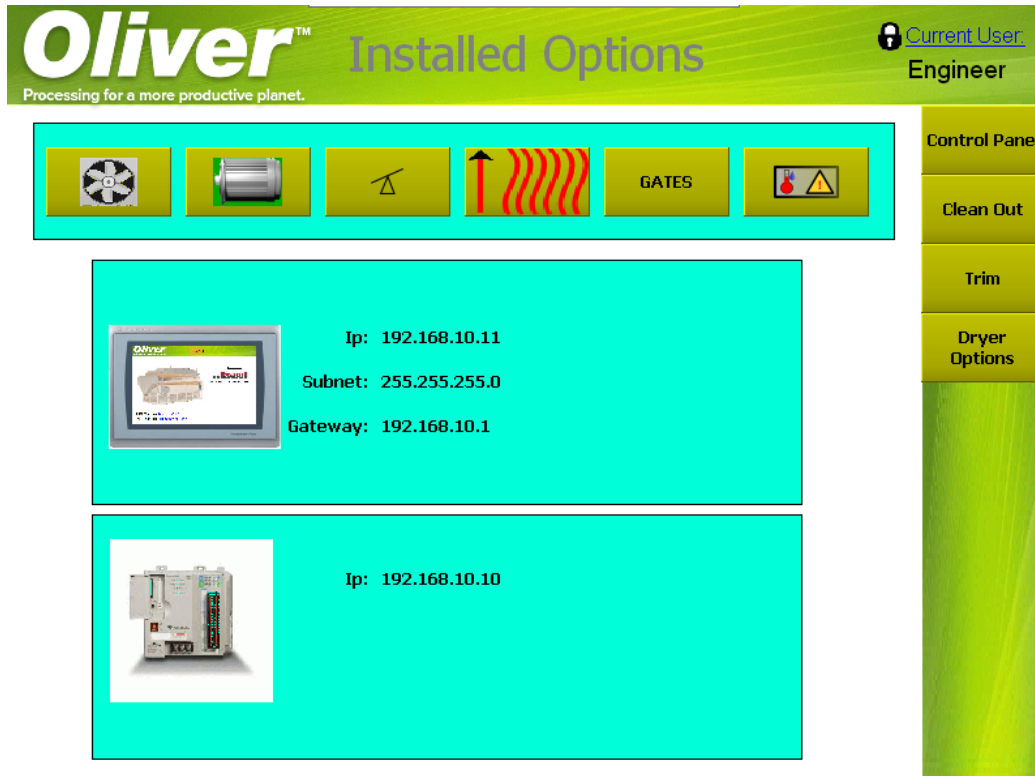

**Figure 5.4:** Dryer's installed options screen

The top of the screen has several menu buttons, see Figure 5.5, for navigation to the options for the subcomponents of the machine including the following items from left to right:

- Fan VFDs
- Deck Eccentric VFD
- Deck End Raise
- Temperature Range
- Gates (on machines with installed End gates)

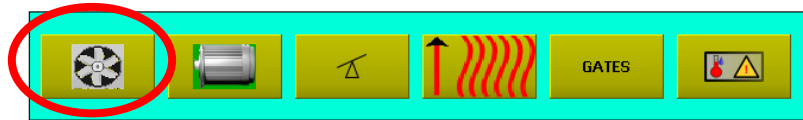

**Figure 5.5:** Dryer's installed options screen top menu buttons

Additionally there are options for setting the IP addresses for the HMI and the PLC.  
**Note: The IP address for the PLC only tells the HMI which IP address the PLC has, it does not set the IP address in the PLC!**

## 5.1 Fan VFDs

To change the available settings for the VFDs for the Fans, press the Fan menu button at the top of the installed options screen. See Figure 5.6.



**Figure 5.6:** Selecting the Fan VFD Options

This will cause a popup window to open, as shown in Figure 5.7.

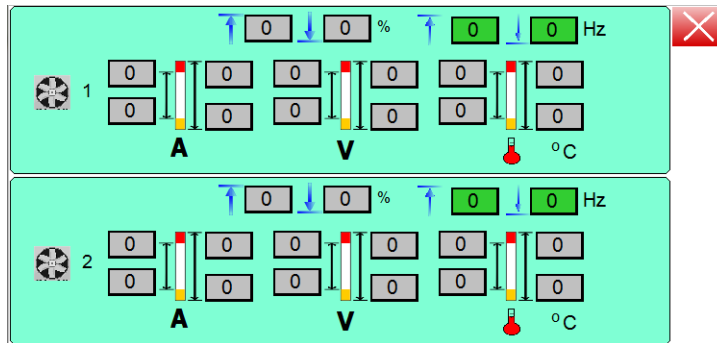

**Figure 5.7:** Fan options pop up window

The pop window will show the appropriate number of VFDs for the machine model. In this case Figure 5.6 shows the two fans for the DVX410 or DVX307 platforms. For each VFD there are options for setting the scaling factors for the Fan speed and for setting alarm values for the output current (A), DC Bus Voltage (V), and the VFD temperature (Celsius) for the VFD driving the Fan motor.

### 5.1.1 Fan Speed Scaling

In the top of each area for the individual fans there are input boxes for setting the scaling factors for the fan speed. These will impact both the values that can be input on the control panel screen for the fan speed, as well as how the PLC scales the command when it sends it to the VFD. Figure 5.8 shows the boxes related to setting the scaling.

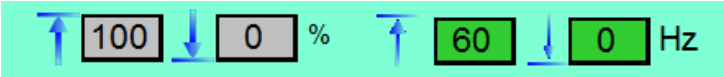

**Figure 5.8:** Fan scaling options

The grey boxes on the left are for the input scaling for the speed, and are in % units. In other words these are the boxes that put the limitations on the commanded speed from the control panel. **Note: For a Dryer with electric or powerflame heat options, the lower limit must not allow the user to set the fan below 50%!** The green boxes on the left are for setting the hertz values that correspond to the minimum and maximum % values in the grey boxes.

As an example, say Fan 1 has a VFD that is allowed to operate from 0 to 60 hz, and we want that to correspond to 0 to 100% for the user. For a dryer with no heat, the options would be set as they are in Figure 5.9. This will allow the dryer to be commanded at the control panel to go from 0% to 100% and the VFD will then operate from 0 to

60 Hz. **Note:**The frequency scaling values do not change the forced max and min frequency values that are programmed into the drive itself. If the VFD has a higher minimum or lower maximum value internally programmed for the frequency than what is in the green boxes, then the VFD speed will not operate to the full range specified on this screen!



**Figure 5.9:** Fan scaling Example for Dryer with no heat

As a second example, say that Fan1 can still can operate from 0 to 60 Hz, but you want the operator to only be able to command it from 50% to 100% of this value, then the setup would look like Figure 5.10 <sup>3</sup>.



**Figure 5.10:** Fan scaling Example for Dryer with heat

Notice that since the minimum and maximum % must correspond to the minimum and maximum frequency in Hz, that both ranges had to be truncated or altered.

Setting the % limits in the grey boxes limits the range of values that the user can input on the control panel screen. In the second example, the limits were set to 50% and 100%, and Figure 5.11 shows that when the user attempts to change the commanded speed from the control panel that the min and max allowed values are indeed 50% and 100%.

<sup>3</sup>for further help see Oliver’s training video “Setting up the Fan VFDs”



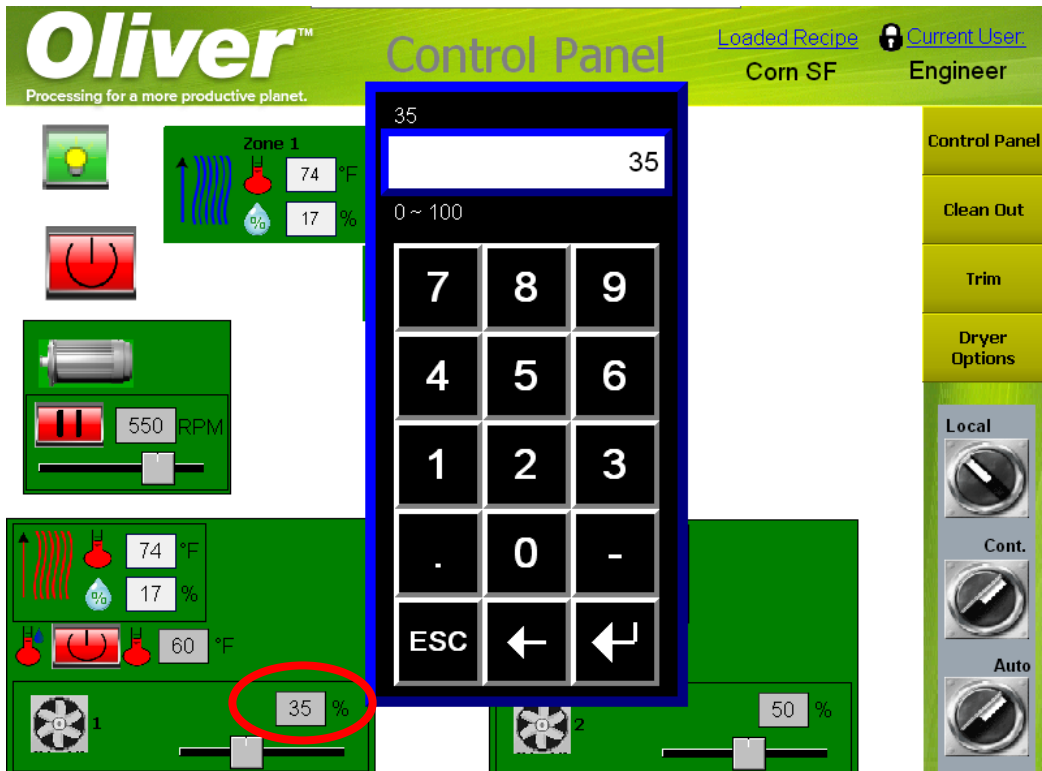
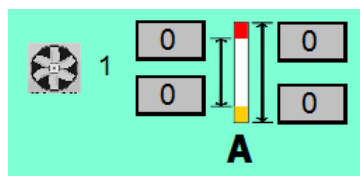

**Figure 5.11:** Changing Fan 1 speed command for Example 2

### 5.1.2 Fan Current, DC Bus Voltage, and Temperature alarm limits

The Fan VFDs have settings for alarm limits for the output current, dc bus voltage, and temperature of the VFD. All of them function in the same way, they just have different units, so we will just look at one of them and then the reader can apply it to the rest of them<sup>4</sup>.

Consider the output current settings, in amps (A), shown in Figure 5.12. There are two sets of grey input boxes, one set on the right side, one on the left.



**Figure 5.12:** Setting output current (A) limits for Fan 1

The grey input boxes to the right are used to indicate the full range of values the output current, in amps can take on. The boxes on the left are used to set values for the lower and upper alarm values, if needed. For example, if the VFD drive should output a maximum of 15 amps during steady state operation, and the customer wished the screen to have an indicator showing that it has exceeded 12 amps so they know it is starting to overamp, then the following would be the way the screen would be set up if no lower alarm is used and the lower limit is zero amps.

<sup>4</sup>for further help see Oliver's training video "Setting up the Fan VFDs"

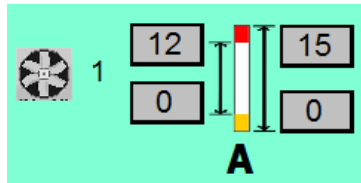

**Figure 5.13:** Setting output current (A) limits for Fan 1 Example

On the control panel, the alarms are indicated on the bar graph in Diagnostic mode. When the output current (or dc bus voltage or temperature) is within the specified limits, the bar will turn blue. If the value is past the upper alarm limit, the bar will turn red. If it is lower than the lower alarm limit, it will turn yellow.

## 5.2 Deck Eccentric VFD

To change the available settings for the Deck Eccentric VFD, press the Deck Eccentric menu button at the top of the installed options screen. See Figure 5.14.



**Figure 5.14:** Selecting the Deck VFD Options

This will cause a popup window to open, as shown in Figure 5.15.

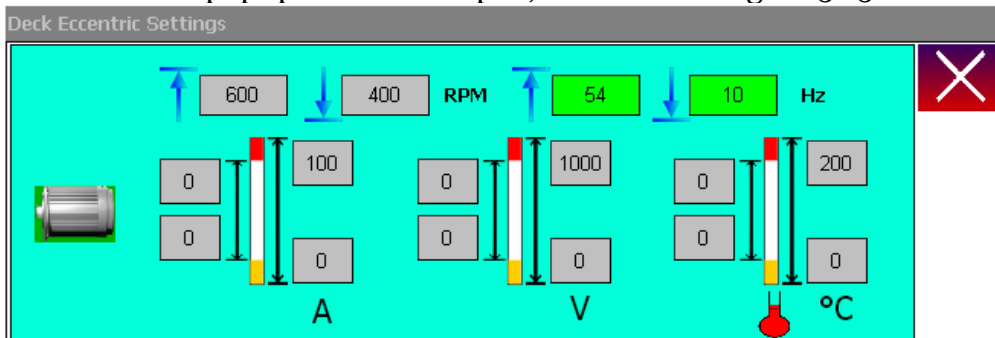
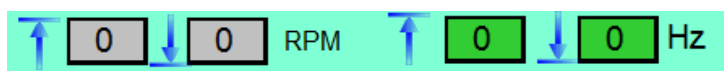

**Figure 5.15:** Deck options pop up window

For the Deck Eccentric VFD there is options for setting the scaling factors for the Deck speed and for setting alarm values for the output current (A), DC Bus Voltage (V), and the VFD temperature (Celsius) for the VFD driving the Fan motor.

### 5.2.1 Deck Eccentric Speed Scaling

At the top of the screen there is input boxes for setting the scaling factors for the deck speed. These will impact both the values that can be input on the control panel screen for the deck speed, as well as how the PLC scales the command when it sends it to the deck VFD. Figure 5.16 shows the boxes related to setting the scaling.



**Figure 5.16:** Deck scaling options

The grey boxes on the left are for the input scaling for the speed, and are in the units of RPMs. In other words these are the boxes that put the limitations on the commanded speed from the control panel. The green boxes on the left are for setting the hertz values that correspond to the minimum and maximum RPM values in the grey boxes.

The typical setup for a DVX Dryer is to allow the range of RPMs to go from 200 to 600 RPM. This normally corresponds to something close to 17 to 53 Hz, as shown in Figure 5.17.

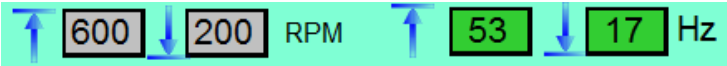

**Figure 5.17:** Deck scaling options Example

Setting the RPM limits in the grey boxes limits the range of values that the user can input on the control panel screen. For the typical setup given above, Figure 5.18 shows that the allowable input value on the control panel screen for the Deck Speed is limited to 200 to 600 RPM.

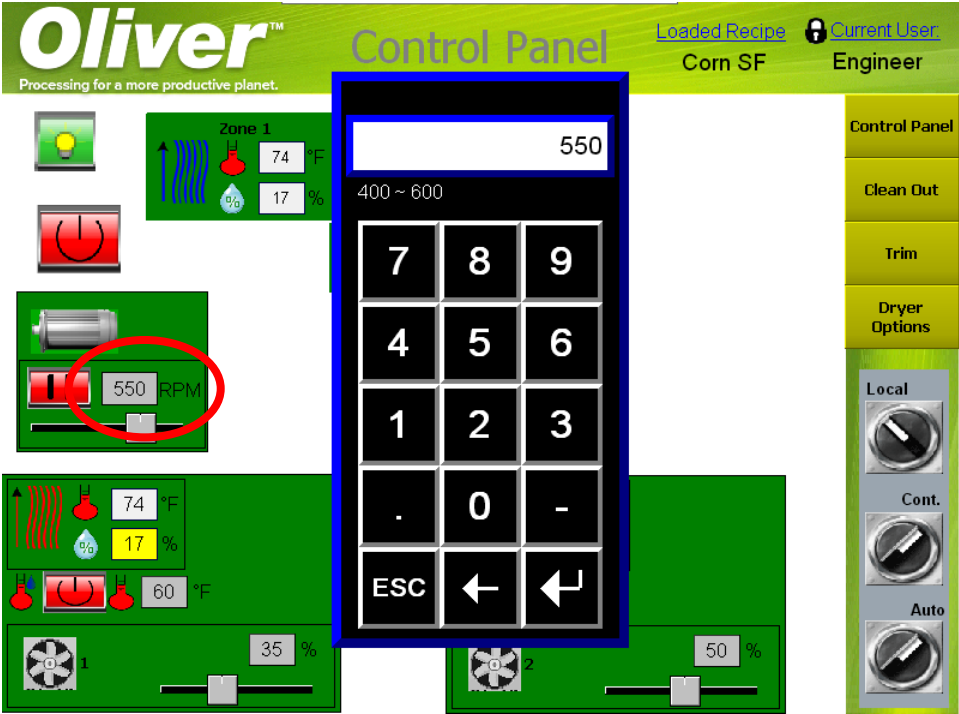

**Figure 5.18:** Changing Deck speed command for typical setup

**5.2.2 Deck Eccentric Current, DC Bus Voltage, and Temperature alarm limits**

The Deck VFD has settings for alarm limits for the output current, dc bus voltage, and temperature of the VFD. All of them function in the same way, they just have different units, so we will just look at one of them and then the reader can apply it to the rest of them<sup>5</sup>.

Consider the output current settings, in amps (A), shown in Figure 5.19. There are two sets of grey input boxes, one set on the right side, one on the left.

<sup>5</sup>for further help see Oliver’s training video “Setting up the Deck VFDs”

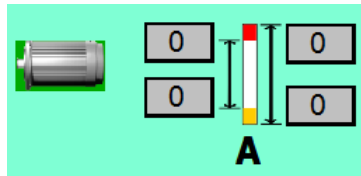

**Figure 5.19:** Setting output current (A) limits for Deck Eccentric

The grey input boxes to the right are used to indicate the full range of values the output current, in amps can take on. The boxes on the left are used to set values for the lower and upper alarm values, if needed. For example, if the VFD drive should output a maximum of 15 amps during steady state operation, and the customer wished the screen to have an indicator showing that it has exceeded 12 amps so they know it is starting to overamp, then the following would be the way the screen would be set up if no lower alarm is used and the lower limit is zero amps.

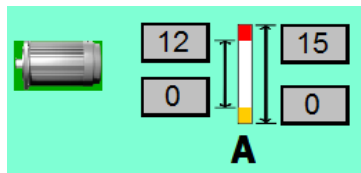
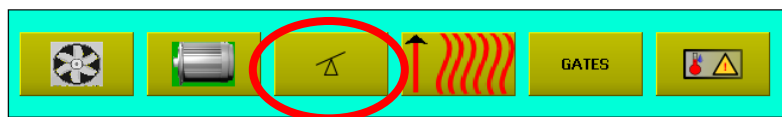

**Figure 5.20:** Setting output current (A) limits for Deck Eccentric Example

On the control panel, the alarms are indicated on the bar graph in Diagnostic mode. When the output current (or dc bus voltage or temperature) is within the specified limits, the bar will turn blue. If the value is past the upper alarm limit, the bar will turn red. If it is lower than the lower alarm limit, it will turn yellow.

### 5.3 Deck End Raise

To change the available settings for the Deck End Raise, press the Deck End Raise menu button at the top of the installed options screen. See Figure 5.21.



**Figure 5.21:** Selecting the Deck End Raise Options

This will bring up the popup screen for the Deck End Raise options, which will allow the engineer user to calibrate the hydraulics for the deck. See Figure 5.22



**Figure 5.22:** Deck End Raise Options Screen

This popup screen allows for the calibration of the deck end raise. The grey input boxes on the left hand side allow for the setting of the upper and lower voltage limits that correspond to 0 and 100% deck end raise. See Figure 5.23.

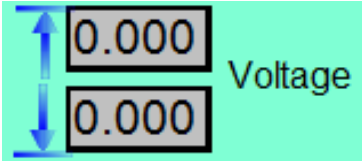

**Figure 5.23:** Inputting Voltage Limits for Deck End Raise

The red up and down buttons will force the deck to extend and retract, allowing the user to force the deck to 0% and 100% deck end raise. The little triangular lights will light up when the deck end raise is increasing or decreasing. See Figure 5.24.



**Figure 5.24:** Forcing the Deck up and Down

The white voltage readout on the right hand side of the popup screen shows the current voltage feedback. See Figure 5.25. **Note: If the voltage is 0 and never changes, then there is no voltage feedback coming back to the PLC.**

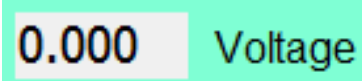

**Figure 5.25:** Voltage Feedback

Using the three areas of the screen, the deck can be manipulated to the fully up and fully down end raise positions and the voltage read back from the white voltage feedback readout and entered into the grey voltage maximum and minimum input boxes to the left. <sup>6</sup>

## 5.4 Temperature Range

The DVX Dryer comes with the ability to set a generic temperature and humidity range and alarm limits for the airchest sections. The primary purpose of the settings are for Dryers that have a heating option. These settings will limit the maximum and minimum temperature that can be set for the heating option, and alarm levels for the temperature and humidity. To set the temperature range, press the menu button at the top of the Installed Options Screen with the heater symbol on it to go to the temperature range popup screen. See Figure 5.26.

<sup>6</sup>see Oliver’s training video entitled “Calibrating the Deck End Raise”

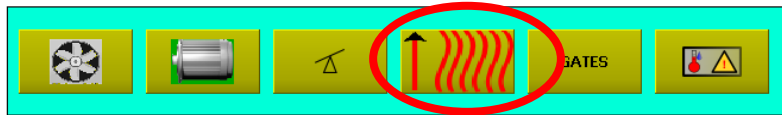

**Figure 5.26:** Selecting the Temperature Range settings and alarms

The temperature range popup screen is below in Figure 5.27.

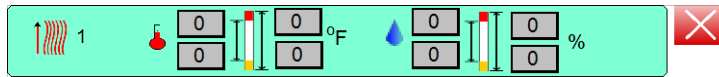

**Figure 5.27:** Temperature Range popup

Each variable, temperature and humidity, has the same sort of set up options, so one will be presented, and the user will realize that the same features apply to both. In the following Figure, 5.28, it is shown that the temperature variable has four settings.

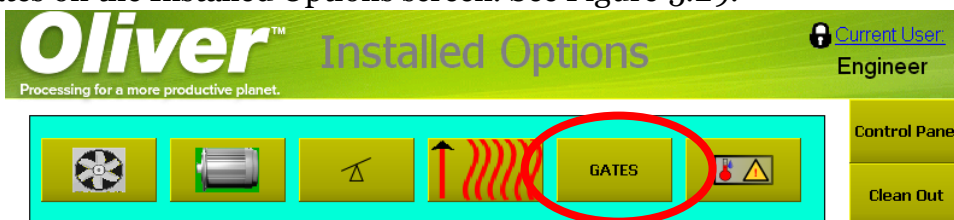

**Figure 5.28:** Temperature Range Settings

The grey input boxes to the right are used to indicate the full range of values the airchest temperature setting for the heater, in degrees F can take on. The boxes on the left are used to set values for the lower and upper alarm values, if needed.<sup>7</sup>

## 5.5 End Gate Option

In some Dryers an End Gate option has been installed. It allows to control the discharge of seed from the dryer. This option will increase the retention time of the seed on the deck for further dry the seed and remove moisture before discharge from the deck. To calibrate the End Gate, press the button that says Gates on the Installed Options screen. See Figure 5.29.



**Figure 5.29:** Navigating to the End gate calibration

The End gate popup screen is shown in Figure 5.30.

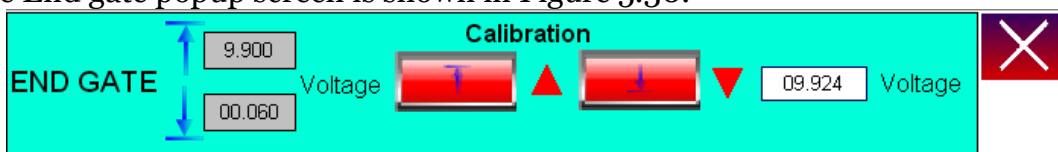

**Figure 5.30:** Blend Door popup screen

<sup>7</sup>see Oliver's training video entitled "Setting the heating unit temperature ranges"

The End Gate calibration is very similar to the calibration of the end raise, except that the End Gate position is not hydraulically driven like the deck, but uses a linear actuator that sends back feedback voltage. On the left hand side Voltage for the zero, or starting position of the linear actuator, and the maximum voltage for the length of travel of the actuator, are entered in the grey input boxes. See Figure 5.31. Typically the lower limit for voltage is always zero, and the upper limit is calculated from the data sheet and the model number for the linear actuator. **Note: If the actuator should not travel the full stroke of the cylinder, then set the upper limit appropriately.**

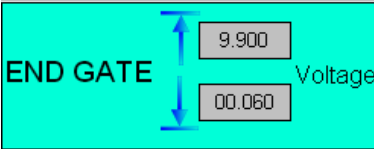

**Figure 5.31:** End Gate Voltage input boxes

The red up and down buttons will force the deck to extend and retract, allowing the user to force the deck to 0% and 100% deck end raise. The little triangular lights will light up when the deck end raise is increasing or decreasing. See Figure 5.32.<sup>8</sup>



**Figure 5.32:** Forcing the End Gate open and close

## 5.6 Machine Hand

Every Dryer is either left or right handed. In order to get the screen to intuitively display the fans and the temperatures and humidities in the airchest and dusthood in the proper order on the HMI from the user’s perspective, the correct option must be chosen. This is done with the simple machine hand button on the Installed Options screen that will display whether the screens are set up for a left or right handed machine. See Figure 5.33 where the screen is HMI is set up for a left hand machine.



**Figure 5.33:** Machine Hand

<sup>8</sup>see Oliver’s training video entitled “Blend Door Calibration”

## 5.7 Machine IP Addresses

The last part of the Installed Options screen is the section for setting IP addresses. There are two sets of IP addresses that can be set.<sup>9</sup>

- HMI's actual IP Address, Subnet, and Gateway
- The IP Address and Port of the PLC in the machine

The default IP addresses from the factory, unless otherwise specified, are:

- HMI's IP 192.168.10.11
- PLC's IP 192.168.10.10
- Gateway 192.168.10.12
- Subnet 255.255.255.0

**Note: The PLC IP address and port setting here will not change the actual PLC IP address or port number, but are only informing the HMI what address to look for the PLC at.**

---

<sup>9</sup>see Oliver's training video entitled "Setting HMI and PLC IP addresses"



**Part III**

**Modes of the Machine**

The Dryer has several different modes. The two main modes are the Auto mode and the Diagnostic Mode. There are several submodes as follows:

- 1. Auto Mode
  - (a) Continuous SubMode
  - (b) Batch SubMode
  - (c) Local SubMode
  - (d) Remote SubMode
- 2. Diagnostic Mode

The modes and submodes are chosen from the Control Panel screen through the use of dials. See Figure 5.33. The following sections will describe the functionality of each mode.

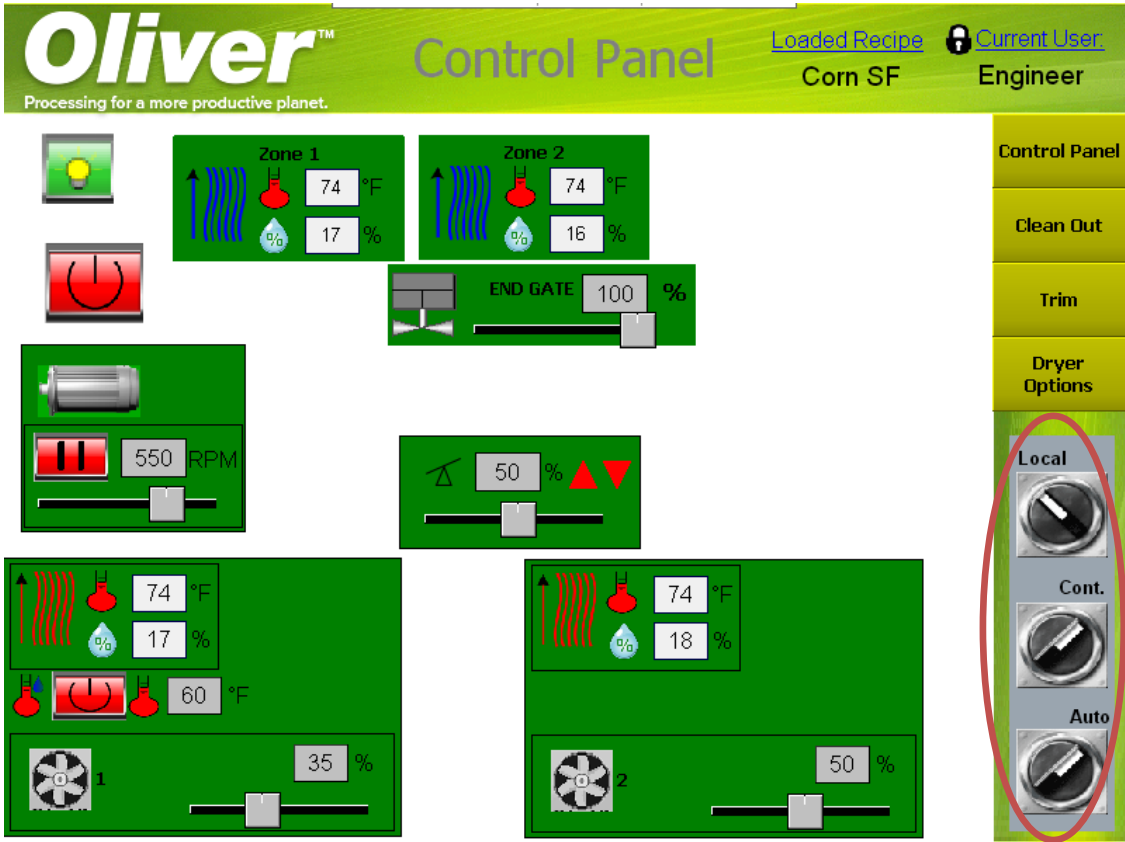

Figure 5.34: Mode Selection

# Chapter 6

## Auto Mode

The normal mode of operation for the Dryer will be the Auto mode. The Auto mode, short for automatic mode, utilizes recipes. The user defines recipes that he wants to recall at a later time that contain the settings for all of the various things like fan speeds, temps, and deck position, then selects the appropriate recipe from a list for the product being dried, then presses the start button, or has the remote SCADA send a start command, and the system will start and operate with the settings in the recipe that has been selected. As mentioned above, there are several other options, called here SubModes, that the user can select while in AutoMode. Two of them are fairly minor; the local and remote submode. The only difference between the two is whether the machine is started at the local HMI, or if it is started via the plant SCADA. If it is in local mode, then a start button will be on the Control Panel screen, and if in remote mode there will be no start button on the Control Panel screen.<sup>1</sup> The other two modes are more complicated and will be explained in detail in the following sections.

### 6.1 Continuous Mode

Continuous Mode is the DVX Dryer's mode for operating with a continuous fluidized bed of seed. The product is expected to come onto the deck in either a batch or continuous manner, and the product flows down the deck continuously and is driven off the deck discharge end by the deck eccentric motion, fan speed, and the end raise. The following illustrates the Control Panel Screen as it would appear in continuous and local modes. Notice that the Local, Cont., and Auto labels are highlighted green to indicate that they are selected. See Figure 6.1.

---

<sup>1</sup>see Oliver's training video entitled "The modes of the Dryer"

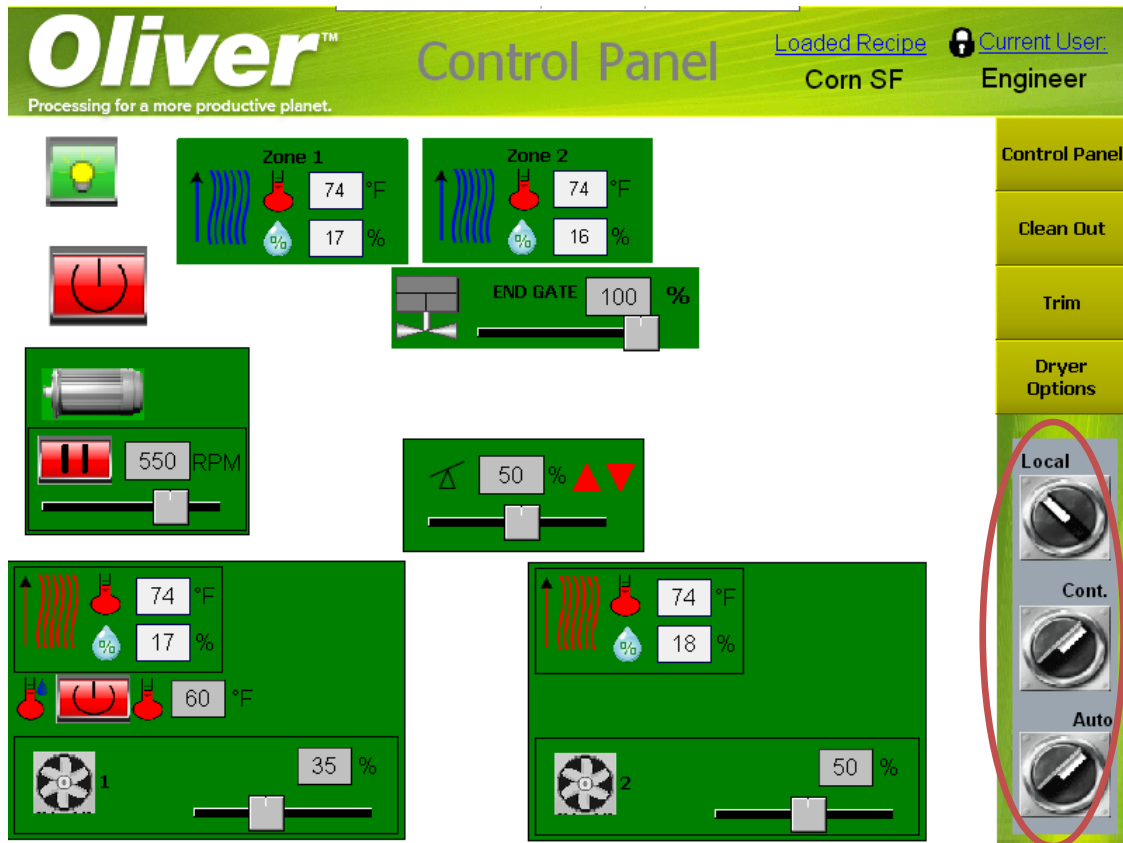

**Figure 6.1:** Control Panel

There are several different areas of interest on the Control Panel mode with the mode and submode selections that have been made. They are as follows:

1. Fan Controls
2. Deck Eccentric Controls
3. End Raise Controls
4. Sensor Readouts
5. Heater Settings
6. Start Button
7. Dust Hood Light Button

### 6.1.1 Fan Controls

The fans are controlled at the bottom of the control panel screen in the area shown in Figure 6.2.

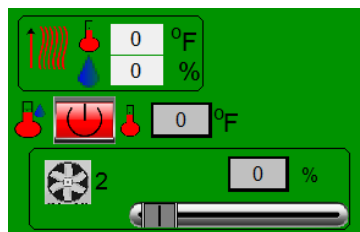

**Figure 6.2:** Airchrest Controls Area

The area shown in the figure is for the airchest two sensor readouts, heater control, and fan controls. The fans are controlled by slider bar or grey input box at the bottom of the screen as shown in Figure 6.3.

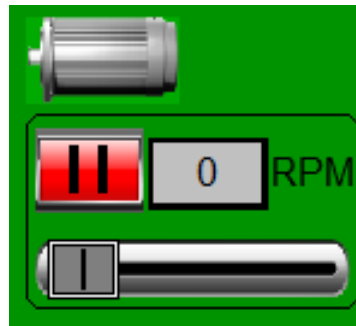

**Figure 6.3:** Fan Controls Area

To change the fan speed, which is in units of %, simply tap on the grey input box to enter an exact value into the keypad that pops up, or use the slider bar to increase or decrease the speed.<sup>2</sup>

### 6.1.2 Deck Eccentric Controls

The Deck Eccentric is controlled in the middle left part of the control panel screen as shown in Figure 6.4.



**Figure 6.4:** Deck Controls Area

To change the deck eccentric speed, which is in units of RPM, simply tap on the grey input box to enter an exact value into the keypad that pops up, or use the slider bar to increase or decrease the speed.<sup>3</sup> The deck eccentric has another control which allows for the pausing or starting of the deck. See Figure 6.5.

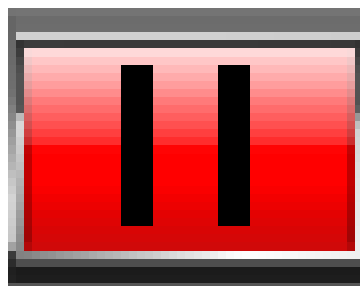

**Figure 6.5:** Deck Eccentric Pause Button

<sup>2</sup>see Oliver's training video entitled "Changing the Fan Speed"

<sup>3</sup>see Oliver's training video entitled "Controlling the Deck Eccentric"

When the button is red, the pause function is not engaged, when green it is engaged and the deck will not shake.

### 6.1.3 Deck End Raise Controls

The deck end raise is controlled from the middle of the control panel screen. See Figure 6.6. To change the deck position, which is in units of %, simply tap on the grey input box to enter an exact value into the keypad that pops up, or use the slider bar to increase or decrease the end raise.<sup>4</sup> There are also two lights that will indicate when the deck should be extending or retracting.

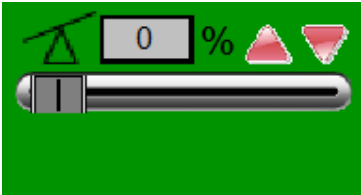

Figure 6.6: Deck End Raise Controls

### 6.1.4 Sensor Readouts

Each DVX Dryer has a temperature and humidity sensor pair in both the airchest and dusthood for each zone. The number of zones is equal to the number of fan controls. The sensors in the airchest are represented by the red heated air sybol, while the similar symbol in the dusthood is blue for the cooler air leaving the dusthood under normal operation. See Figures 6.7 and 6.8



Figure 6.7: Airchest Sensors

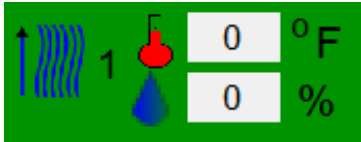

Figure 6.8: Dusthood Sensors

### 6.1.5 Heater Controls

To control the heat in the zones with a heater, there is a start button and a grey input box for setting the heat desired, located above the fan controls in each zone. See Figure 6.9.

<sup>4</sup>see Oliver’s training video entitled “Changing the deck end raise”



**Figure 6.9:** Heater Controls

### 6.1.6 Start Button

In continuous mode, the start button will start the operation of the recipe for the entire machine. The start button has a power symbol on it indicating that when it is pressed and green the machine is energized, and when it is red, the machine is not energized. See Figure 6.10 and 6.11

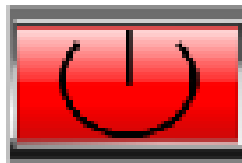

**Figure 6.10:** Start Button - Machine Off



**Figure 6.11:** Start Button - Machine On and recipe running

**Note: When the start button is pressed, all navigation to other screens is locked out. You can't adjust any options on the machine except at the Control Panel screen while the machine is running.**

### 6.1.7 Dust Hood Light

On the control panel screen there is a button for turning off and on the Dust Hood light. When the light is off, the button will be red with a black light bulb, and when on it will be green with a yellow light bulb. see Figure 6.12 and 6.13



**Figure 6.12:** Dust Hood Light Button - Light Off

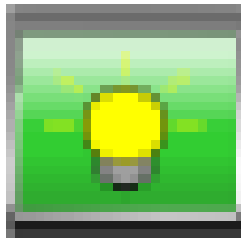

**Figure 6.13:** Dust Hood Light Button - Light On

## 6.2 Batch Mode

The batch mode of the Dryer is used for running batches that stay on the dryer for an extended amount of time, either on the full deck or on baskets at different positions along the deck. The batch mode then utilizes control through various timing operations related to a batch run. Batch mode has all of the same controls as the continuous mode with the following additional controls:

1. Batch Cycle Timer
2. End Raise Cycle Timer
3. Deck Shake Timer
4. Current Timer Readouts
5. Differential Temp Alarm

The Control Panel screen, when in batch mode, looks like the following:

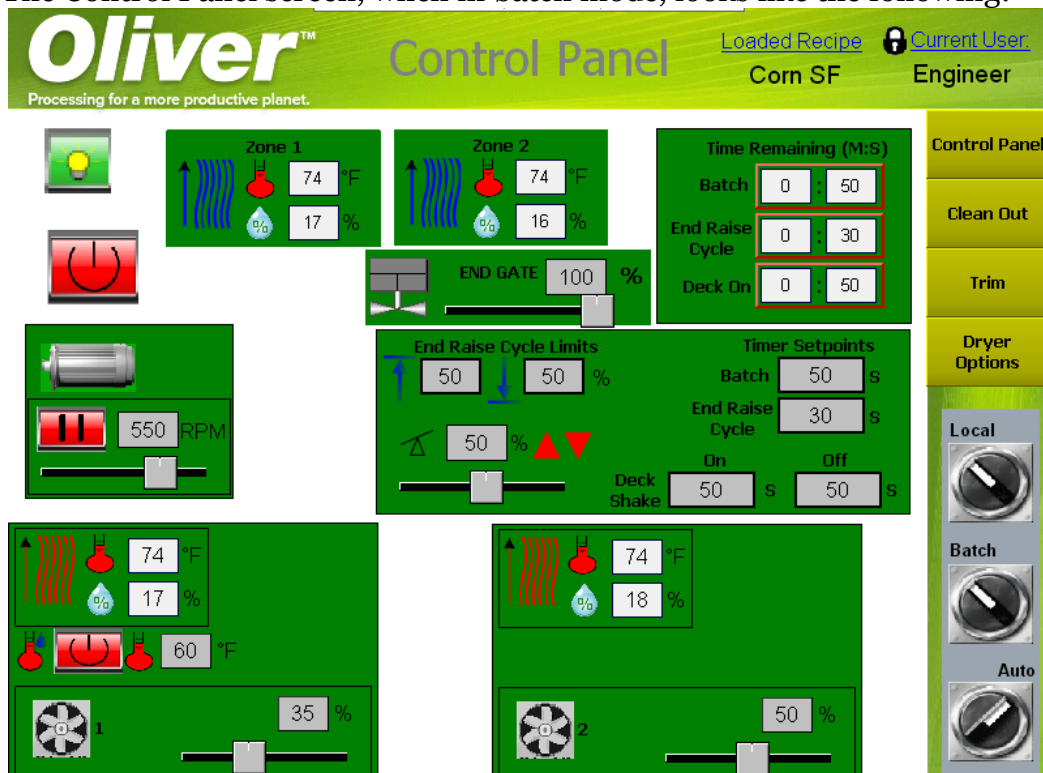

**Figure 6.14:** Control Panel in Batch Mode



### 6.2.1 Batch Timer

The batch timer is used to time an entire batch. At the current revision of the code, the batch timer will automatically control the opening and closing of the end gate when the entire deck is used for the batch. At the beginning of each batch cycle the gate will close, and it will re-open at the end of a batch cycle so adjustments can be made to the deck to bring the seed off of the deck. The batch time is in units of seconds, and is controlled via an input box in the middle of the screen next to the end raise controls. See Figure 6.15 The batch timer serves as the master timer for all of the other timers used for control of the Batch. They will not function and time anything until the batch time has been started. This is done by turning on the machine via the start button just as one would do in continuous mode.

**Note: The batch timer settings cannot be altered while a batch is running. The timer will not reload the new setting until the current batch is stopped and a new one started.**

**Note: A new batch is started by turning off the start button and turning on the machine back on.**

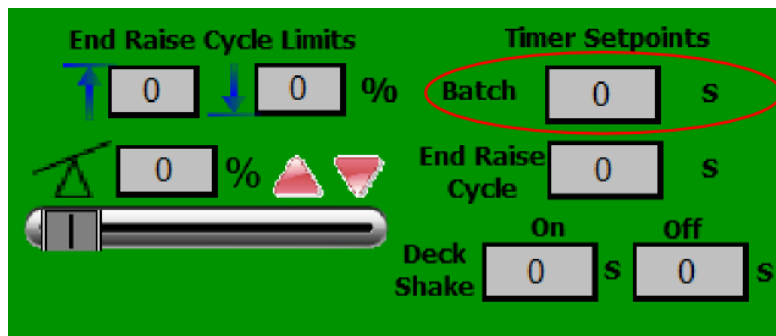

Figure 6.15: Inputting Batch Timer settings for Batch Time length

### 6.2.2 End Raise Cycle Timer

In order to stir seed on the deck or in the baskets, a common need for batch dryers, there is a timer for stirring the deck. It has two different controls, both in the same area as the Batch Timer setting was found. See Figure 6.16.

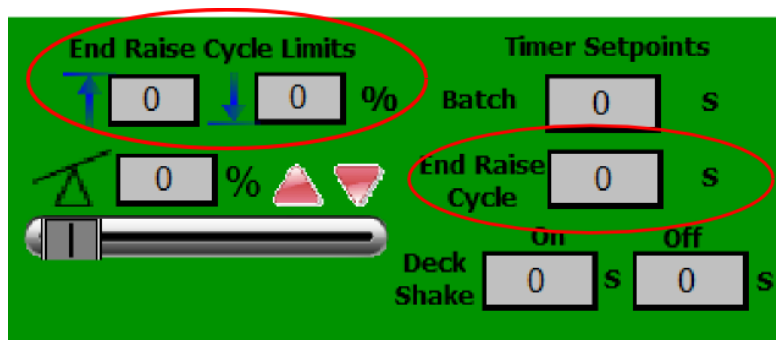

Figure 6.16: Inputting Batch Timer settings for End Raise Cycle

The first setting is the End Raise Cycle Limits setting. When the deck is stirred it will go to an upper limit, then to a lower limit, before returning to the normal deck position.

For example, the limits might be set such that the upper limit is 80% end raise, the lower limit 30% end raise, and the recipe setting being 50% end raise. Figure 6.17

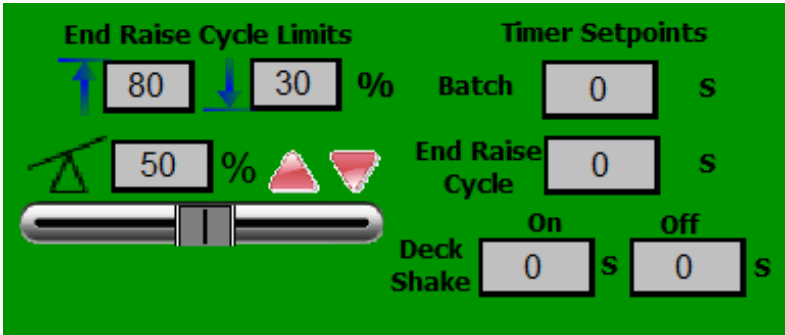

Figure 6.17: End Raise Cycle Limits Example

The second setting is to set the length of time between the stirs of the deck. That time does not include the amount of time it takes the deck to go all the way up, then down, and to return to its original position. It is the amount of time between the last time the deck returned to its original position and when it starts the new stirring cycle all over again. If the user wanted to set the time between stirs to be 5 seconds, and keep the settings from the previous example, then it would look like Figure 6.18

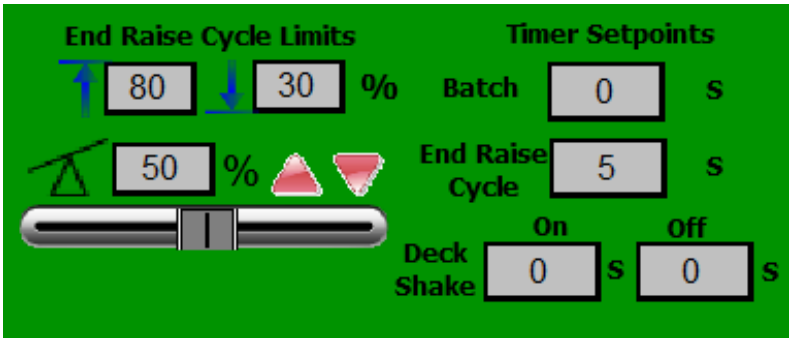
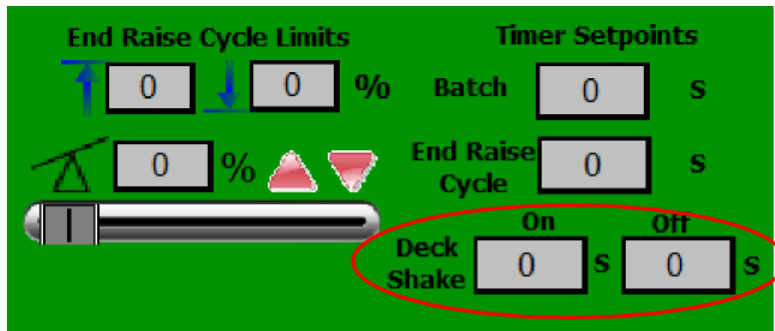

Figure 6.18: End Raise Timer 5 Seconds Example

**Note: The cycle timer setpoint cannot be altered while a batch is running. The timer will not reload the new setting until the current batch is stopped and a new one started.**

### 6.2.3 Deck Shake Timer

For Batch Mode, the deck shake can be put on a timer to turn the deck shake off and on throughout the batch cycle. This is done with the use of two grey input boxes, used to set how long the deck will be on, followed by a period of how long the deck will be off. These settings are below the End Raise Cycle settings. See Figure 6.19



**Figure 6.19:** Deck Shake Timer

For example, if the deck should start out on for 2 seconds, then off for 10 seconds, and repeat this cycle for the entire batch cycle of 30 seconds, then Figure 6.20 illustrates the settings that would need to be input into the appropriate grey input boxes.

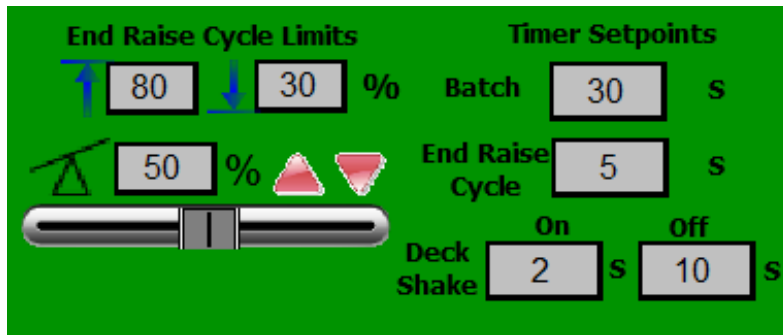
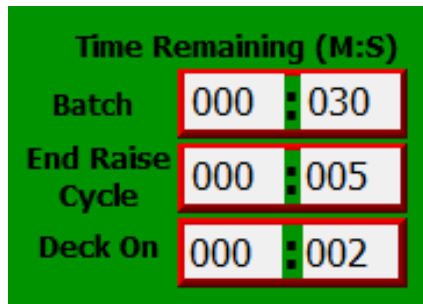

**Figure 6.20:** Deck Shake Timer Example for 2 seconds on, 10 seconds off, repeated through a 30 second batch cycle

**Note: The deck shake timer setpoint cannot be altered while a batch is running. The timer will not reload the new setting until the current batch is stopped and a new one started.**

#### 6.2.4 Current Timer Readouts

The Control Panel screen, in Batch Mode, also has a readout for the time remaining for each of the timers set above. It displays the remaining time in minutes: seconds. For the example shown in Figure 6.20, the time remaining panel would look like Figure 6.21 before the machine is started.



**Figure 6.21:** Time Remaining

The timers will then count down until they reach zero, and then restart the cycle. When the Deck is off, then the Deck On Timer will change to a Deck Off Timer, then back to Deck On when the timer reaches zero. See Figure 6.22.

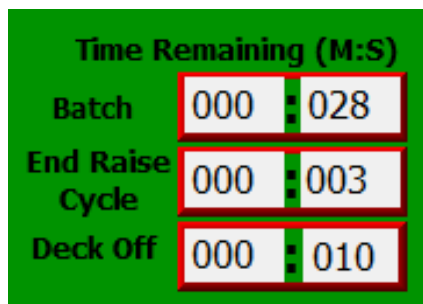

**Figure 6.22:** Time Remaining Deck Off

### 6.2.5 Differential Temp Alarm

In Batch mode a differential temp alarm or humidity alarm can be set for the differential temperatures or humidities between the incoming air in the airchest and the Dusthood. Typically early in the drying process, the air coming in from the airchest to the seed is much higher in temperature than the dusthood air temperature. As the seed dries, this temperature difference diminishes. An alarm can be set to display an alarm message on the screen, or to turn external outputs on and off on the PLC controller to indicate that the minimum temperature difference has been met. This alarm is set by pressing the temp alarm button beneath the zone 1 dusthood temperature and humidity sensor displays. See Figure 6.23.

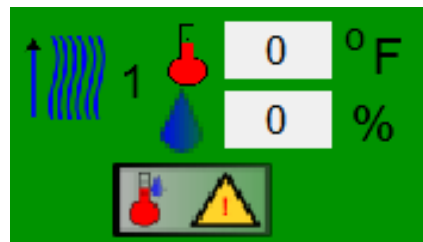

**Figure 6.23:** Navigating to the differential temp alarm settings

This will open the differential temp alarm popup screen. See Figure 6.24.

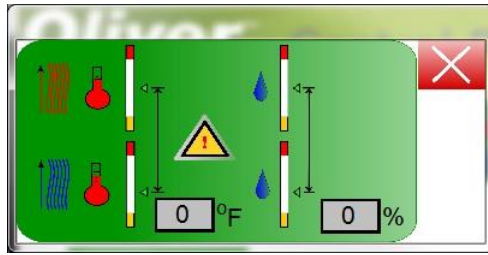

**Figure 6.24:** Differential Temp Alarm Popup Screen

The differential temperature and humidity are set in the appropriate grey input boxes.

## 6.3 Local and Remote Mode

The last of the Auto Mode submodes is the selection between local and remote mode. The only function of this setting is to take the stop/start button off the HMI, and for the PLC to wait for the start/stop command from the plant SCADA. It is relevant in both batch and continuous mode. It is set by using the dial for local and remote on the Control Panel Screen.

## 6.4 Clean Out

The automatic mode has a cleanout functionality that can be accessed using the Clean Out menu button in the menu to the right of the screen. **Note: This button can only be pressed if the machine is not currently running.** The cleanout screen function is intended as a two-stage process for getting the remaining product off the deck and blowing out the dust from the deck. Any user can access the Clean Out screen. Figure 6.25 shows the clean out screen.

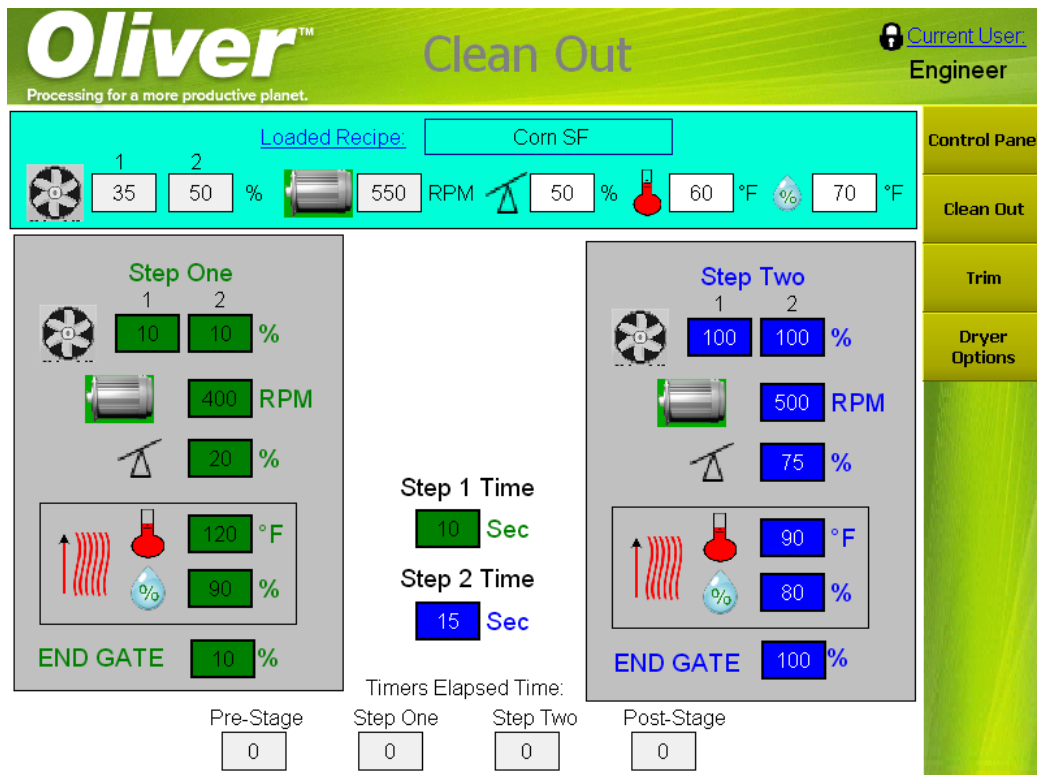

**Figure 6.25:** Clean Out Screen

The top of the cleanout screen shows the currently loaded recipe and the current values for the Fan speed, deck eccentric speed, end raise position, and the temperature and humidity settings for the burners or air control units, if installed. See Figure 6.26

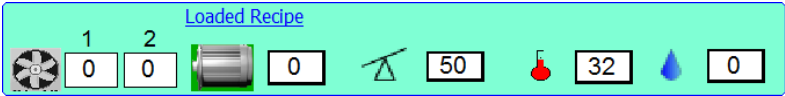

**Figure 6.26:** Loaded Values Clean Out Screen

The middle of the screen, where the two big grey background boxes are, is for setting the values of the two main steps of the automated clean out function. The first step is on the left, the second step is on the right. Enter in the values you wish the settings for fans, deck, eccentric, etc to take on during the clean out cycle during both steps, as well as the length of time you wish the step to take in seconds. Once that has been done, press the start button, and the cycle will start. As with the control panel screen when the machine is running, navigation will not be possible while the cleanout is running. Changes to the settings or the length of time during the cleanout cycle will not take effect unless the cycle is stopped and then restarted so the new values will load into the timer and the process starts again. The bottom of the screen shows several elapsed times for various stages of the cleanout process. See Figure 6.27

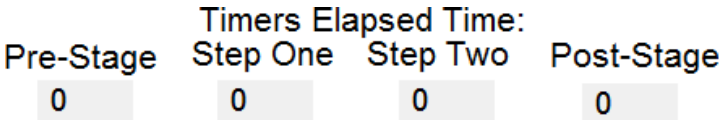

**Figure 6.27:** Time Elapsed for each stage

During the cycle, a pre-stage timer is set for the approximate amount of time it takes the cleanout cycle to load the current values and to prepare the rest of the cycles, then the stage one values are loaded into the commanded values for the machine, then stage two, then a post stage where the values return to the values that were in place before the whole process was started. The timers will count up as each stage is engaged, showing where in the process the clean out function is.<sup>5</sup>

## 6.5 Trim

Trim values can be loaded that limit the operator from changing the values of the settings on the control panel for the individual components past a certain range. The Trim screen can only be reached by a Supervisor and not the normal Operator user. To get to the Trim screen, log in as a supervisor, then press the trim settings menu button on the menu on the right side of the screen. The trim screen is shown in Figure 6.28.

<sup>5</sup>see Oliver’s training video entitled “Using the Clean Out Function”

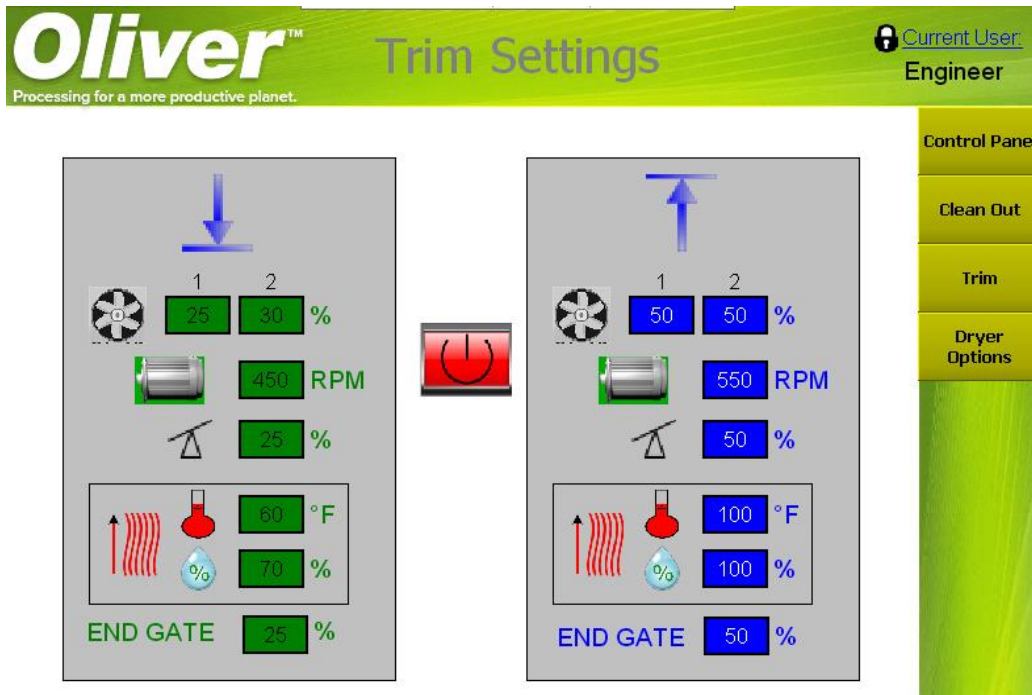

**Figure 6.28:** Trim Settings

The upper and lower limits, on the right and left respectively, allow the Supervisor to set the range that the corresponding values can take on. For example, if the Supervisor wants to limit the Operator to being able to change the Fan 1 speed from 40% to 55%, then the setting would look like they do in Figure 6.29.



**Figure 6.29:** Trim Settings Fan1 Example at 40% to 55% trim settings

To engage the trim mode use the start button on the trim screen. If the button is red, the trim is not engaged, if the button is green, the trim is engaged. <sup>6</sup>

## 6.6 Changing Recipes

The recipes are the main driving force behind the Auto Mode. They are used to store settings to be used again next year, or when a run needs to be changed from one product to another, and keep the operators from having to remember every setting or having to read them back off of written documents every season or run change. The loading and saving of recipes can be done by the standard Operator user, while the creation or deleting of recipes in the list must be done by a Supervisor user. The recipe screen is navigated to by pressing the Loaded Recipe Hyperlink in the top right corner. See Figure 6.30.

<sup>6</sup>see Oliver's training video entitled "Using the Clean Out Function"



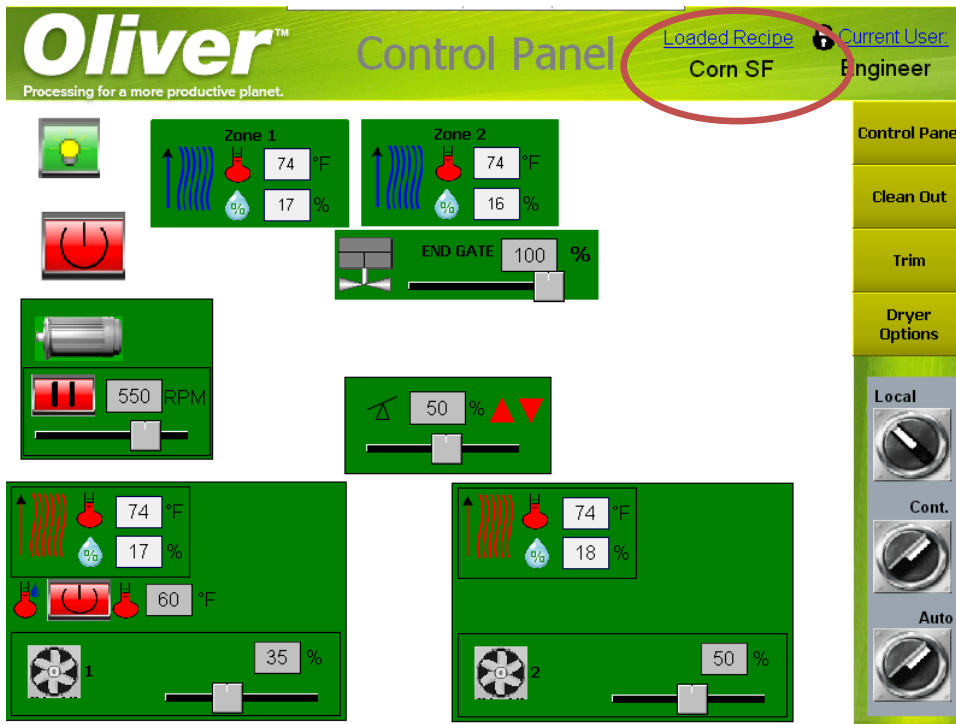

**Figure 6.30:** Navigating to the Recipe screen from the Control Panel

For the Operator user, the Recipe Setup screen looks like Figure 6.31.

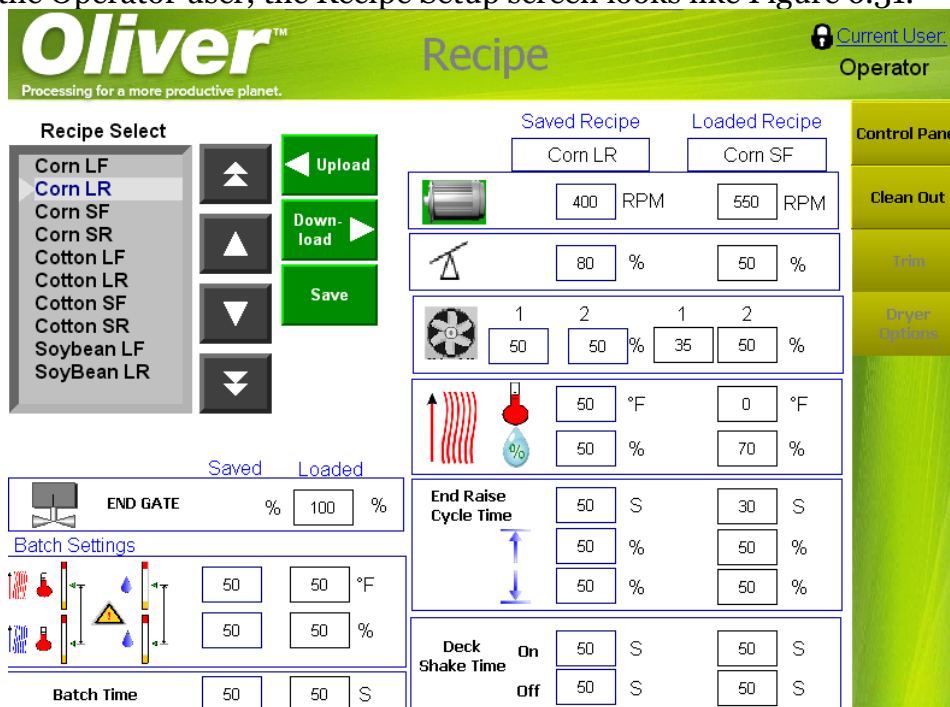

**Figure 6.31:** Recipe Setup Screen as an Operator user

From this screen recipes can be loaded and saved via the Load Recipe and the Save Recipe buttons. There are two columns with values for each setting; the saved recipe column and the loaded recipe column. The loaded recipe column, as the name infers, indicates the name of the last recipe loaded, as well as the CURRENT values for the fans, deck eccentric, end raise, etc. These are not necessarily what was in the recipe itself, but reflect the current values as they appear on the Control Panel. The values in the loaded recipe column can be changed, either from the Recipe Settings screen or from the



Control Panel, and then saved into the currently highlighted recipe with the Save Recipe button. The recipe name in the loaded recipe column can also be changed from the Recipe Settings Screen. **Note: Make absolutely certain that the Loaded Recipe name and the recipe highlighted and shown in the saved recipe column are the same or that you intend to overwrite the name in the saved recipe highlighted, as the recipe name in the loaded recipe columns WILL overwrite the name of the highlighted recipe!**

The values in the saved recipe column are the values in the currently highlighted recipe in the Recipe Select menu. They can only be changed by saving the recipe with the save recipe button. The current values of the recipe in the saved recipe column can be loaded into the loaded recipe column using the Load Recipe button.

The Supervisor user also has the ability to add and delete a recipe from the Recipe Select Menu. The Recipe Setup screen when logged in as a Supervisor is shown in Figure 6.32

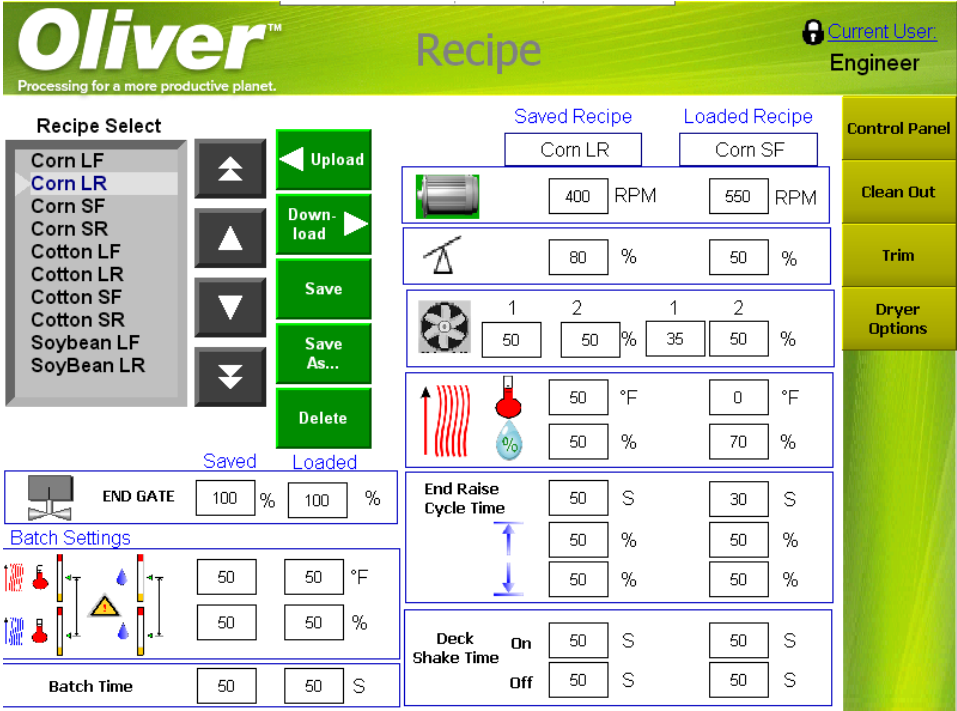

**Figure 6.32:** Recipe Setup Screen as a Supervisor/Engineer user

The Supervisor has the use of two more buttons on the Recipe Screen; the New Recipe and the Delete Recipe buttons. To delete a recipe, simply highlight the recipe that needs to be deleted in the list and hit the delete key. To add a recipe, start by clicking the new recipe button. This will create a new recipe with the same name as the currently highlighted recipe. **Note: The new recipe will be at the bottom of the list, which may mean that you have to scroll down to see it.** The new recipe will now be the highlighted recipe. See Figure 6.33. There are now two recipes with the name Corn LR. To change the new recipe’s name or setting values either use the Loaded Recipe column to change the values in the loaded recipe and save it as you would as an operator user, or click on the values in the saved recipe column and change them to what you want them to be. This includes the name. **Note: If the user changes the new recipe by changing the values in the loaded recipe column then saving the recipe, it will change the Control Panel settings to the new values.** If any values are changed by clicking on the values in the saved recipe column and changing them directly, then an

update recipe and a cancel button will appear. See Figure 6.34. To change the actual recipe in the HMI with the new values entered into the saved recipe column, press the update recipe button, or to cancel, hit the cancel button.<sup>7</sup>

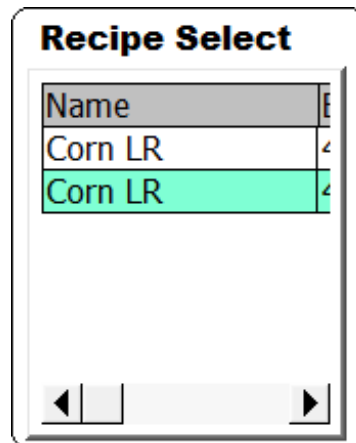

**Figure 6.33:** Recipe List with a new Recipe

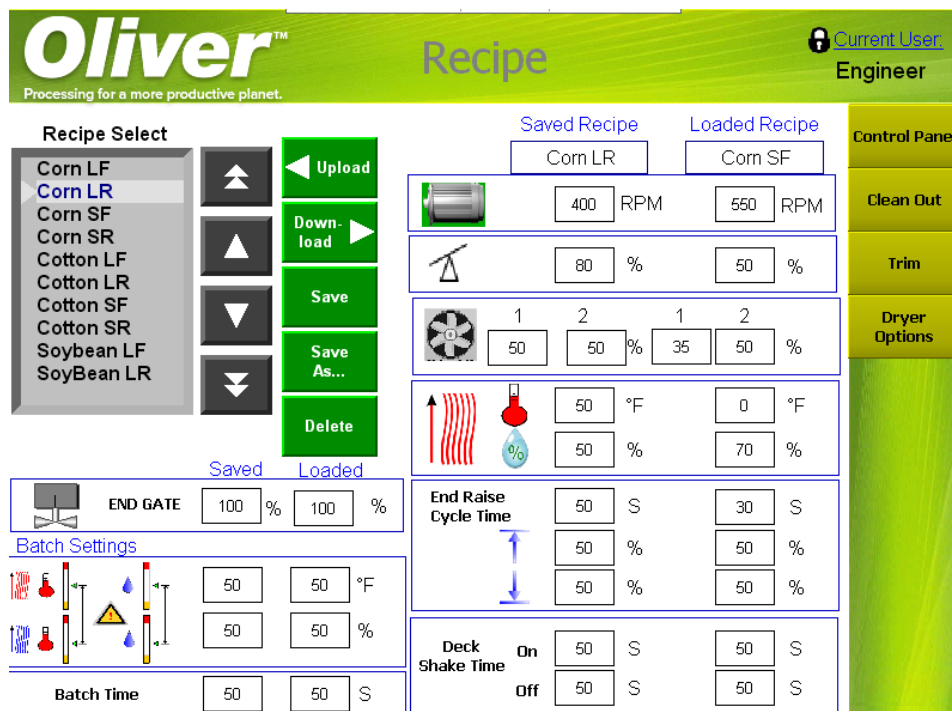

**Figure 6.34:** Recipe Setup Screen with Update Recipe and Cancel buttons

<sup>7</sup>see Oliver's training videos entitled "Adding New Recipe and Deleting Old Recipe" and "Loading and Saving Recipes"

# Chapter 7

## Diagnostic Mode

Unlike the Auto Mode, which uses a recipe to operate all of the machine’s components simultaneously, the diagnostic mode is used for troubleshooting purposes only and starts each component individually. In order to set the machine to the Diagnostic Mode, the user must be logged in as a Supervisor. In diagnostic mode the control panel screen will look like Figure 7.1.

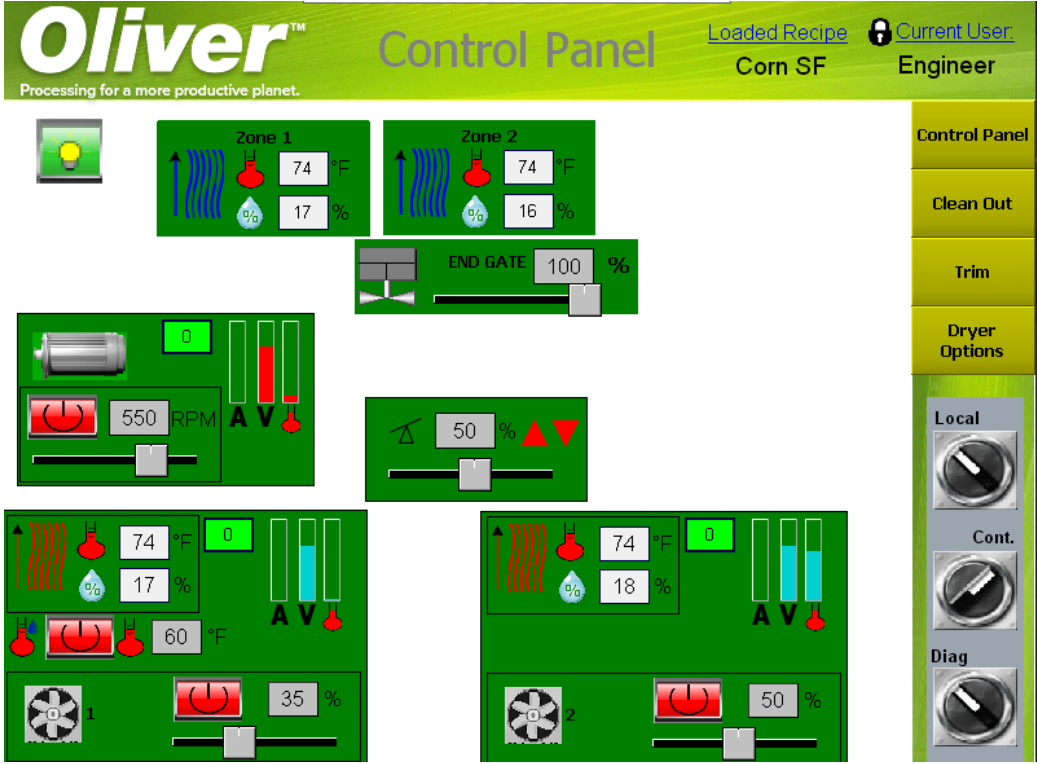

**Figure 7.1:** Control Panel in Diagnostic Mode

There are three additional tools that appear on the screen for diagnostic mode.

- start buttons for the fans and deck eccentric
- feedback for the deck end raise position
- graphs for the amperage, voltage, and temperature of the drives and readout of the drive frequencies for the fans and deck eccentric

## 7.1 Start Buttons for the Fans and Deck Eccentric

In diagnostic mode the fans and the deck eccentric are started independently of each other. Each of them will have their own start button. See the areas marked with a red circle in Figure 7.2.

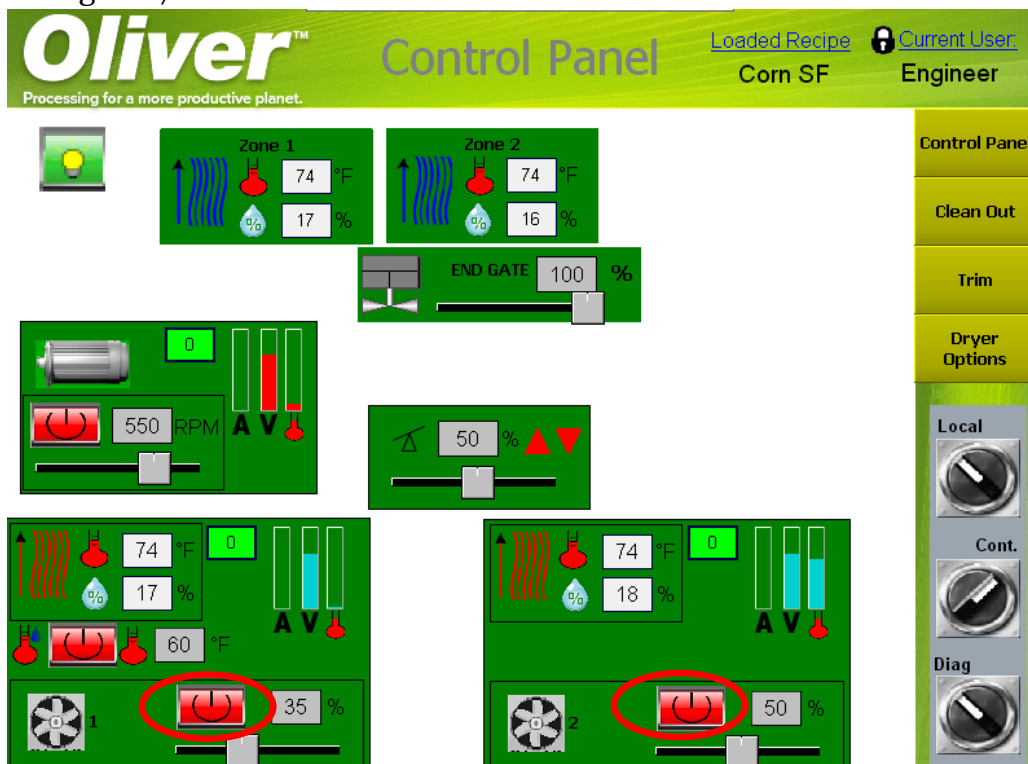

**Figure 7.2:** Control Panel in Diagnostic Mode with Start Buttons Highlighted

## 7.2 Deck End Raise Feedback

The deck end raise has a display for the voltage feedback for the deck. This will allow the supervisor user to see if there is a voltage change as the deck moves, or if the voltage is not registering a change. This can be used for troubleshooting issues where the deck moves to the extremes and continues to try to move. See Figure 7.3.

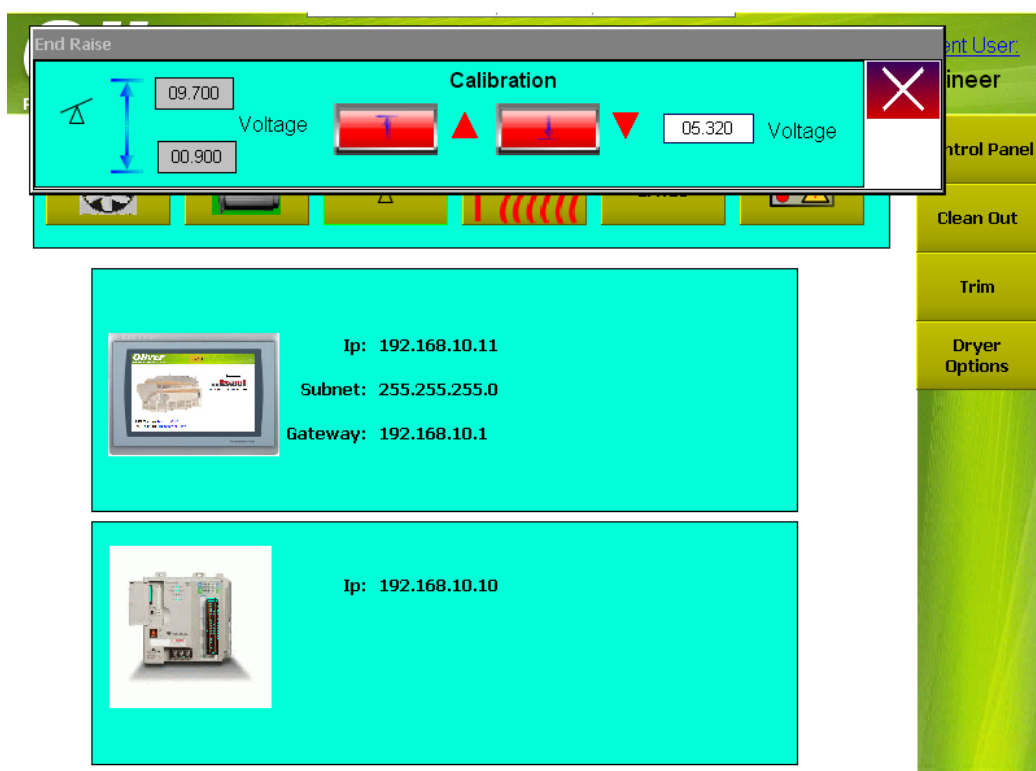

**Figure 7.3:** Control Panel in Diagnostic Mode with Deck End Raise Feedback Highlighted

### 7.3 VFD Graphs and Readout

Each of the fans and the deck eccentric have readouts that display the voltage, amperage, temperature, and the output frequency in hertz of each drive. This can be used to diagnose the current condition of the drive, monitor the drive for excess voltage, amperage, and temperature, as well as make sure the drive is getting to the expected output frequency at different commanded speeds. The amperage, voltage, and temperature graphs upper and lower limits, as well as alarm conditions, are set by the engineer who setup the Dryer. These limits should not be changed unless instructed to do so. The graphs themselves will display the relative value of the amperage, voltage, and temperature to the upper and lower limits, showing how close those variables are to the limits. If those values for the drive are in a safe zone, the graphs will be blue. If the graphs pass an alarm value set for the variable by the engineer, then the graph will turn red. Likewise, if a lower alarm limit is crossed, the bar will turn yellow. Figure 7.4 shows the various graphs and the readout for the VFD output frequency.

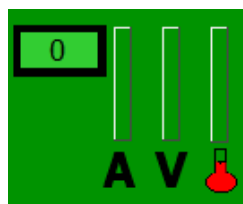

**Figure 7.4:** Graphs for Amperage (A), Voltage (V), and Temperature and the readout for the VFD frequency in diagnostic mode

# ***Oliver***<sup>TM</sup>

**Innovate. Build. Repeat.**

Oliver Manufacturing Company • 27151 Harris Road • La Junta, CO 81050 • (888) 254-7814

[olivermanufacturing.com](http://olivermanufacturing.com)